

TIME STAMP

TIME/DATE/NUMBERING PRINTER

USER'S MANUAL



1. The details of this User's Manual are subject to change without prior notification.
2. This User's Manual has been prepared with the utmost care to cover all aspects of the time stamp's use.
If you feel, However, that some explanations are inadequate, unclear, or difficult to understand, please do not hesitate to contact the dealer or the shop from which you have purchased your Time Stamp.
3. Be sure to use your Time Stamp after you have fully understood the hardware and software specifications and limits.

SPECIFICATIONS

- Clock accuracy: Monthly accuracy ± 15 sec. (at ordinary temperatures)
- Calendar: Year up to 2099, Automatically adjusted to leap years, 31-day months and months with thirty or fewer days, and the day of week.
- Printing system: Dot matrix.
- Power failure compensation: Three years of cumulative power failure hours after the date of shipment.
- Print at power failure: Optional Ni-Cd battery, 200-time printing or 24 hours.
- Time program: External time signal
Built-in buzzer
Printing a special mark (*)
- Connection of external time signal: No voltage signal output.
- Operating environment: Temperature: -5°C to 45°C , 23°F to 113°F .
Humidity: 20% to 80%, no condensation.
The unit operates normally at temperatures of 5°C or below, but the print density, reaction of the LCD display, and the number of prints at power failure are inferior to those at normal temperature operation.
- Dimensions: 6.14" (W) X 7.36" (H) X 6.85 (D)
156mm (W) X 187mm (H) X 174mm (D)
- Weight: Approx, 4.6 lbs. (2.1Kg)
- Rating: AC 115VAC 50/60Hz 0.51A
AC 230VAC 50/60Hz 0.26A

TABLE OF CONTENTS

1. FEATURES	1
2. PREPARATION	2
3. QUICK EASY SETUP	3
4. OPTIONAL FUNCTIONS	4
5. SETTING THE TIME STAMP	5
6. SETTING THE TIME	6
7. SETTING THE DATE	7
8. SETTING THE 12/24 HOUR FORMAT	8
9. SETTING THE PRINT ORDER	9-10
10. SETTING THE PRINT PATTERN	11-12
11. SETTING THE PREPROGRAMED COMMENTS	13
12. SETTING THE CUSTOMIZED COMMENTS	14-21
13. SETTING THE LANGUAGE	22
14. SETTING THE PRINT METHOD	23-24
15. SETTING THE DAYLIGHT SAVING TIME	25-27
Deleting the Daylight Saving Time setting	28
16. SETTING THE NUMBER	29-30
17. SETTING THE INITIAL NUMBER	31
18. SETTING THE TIME TABLE PROGRAM	32-38
19. SETTING THE EXTERNAL TIME SIGNAL / BUILT-IN BUZZER	39
20. SETTING THE PASSWORD	40-41
21. RESET	42
22. WALL MOUNTING	43
23. REPLACING THE RIBBON CARTRIDGE	44-45
24. CHARACTER CODE FOR ALPHANUMERIC	46-49
25. INSTALLING THE Ni-Cd BATTERY (OPTIONAL)	50
26. CONNECTING THE EXTERNAL TIME SIGNAL	51
27. TROUBLESHOOTING	52

1. FEATURES

Main applications: Payroll / job cost recorder, time stamp or numbering machine.

- The Quartz Time Stamp
 - Dot-Matrix printer
 - Perpetual calendar
 - Automatic daylight saving time
 - 4 options for print activation
 - Automatic
 - Manual
 - Semi-automatic
 - Combination
 - Adjustable print position
 - 7 languages options for print
 - Prints numbers/date
 - Time table program
 - Special mark printing
- 13 preprogrammed comments
 - Alphanumeric printing
 - Selectable 4-digit year imprint
 - 12 or 24 hour format
 - Regular minute, 1/10, 1/100 or 5/100 of an hour
 - Password for program protection
 - Digit LCD (Date, Hour, Minute, Day of the week indication)
 - Wall or desktop mount
 - Full power reserve (optional)
 - Built-in buzzer (optional)
 - External time signal (optional)

Caution:

Do not use in places:

- Subject to high humidity and dust
- Exposed to strong or continuous vibrations.
- Exposed to direct sunlight.

“CAUTION: DUSCONNECT SUPPLY CORD BEFORE OPENING.”
“WARNING: EXPLOSING HAZARD: DO NOT RECHARGEABLE BATTERIES”

2. PREPARATION

Package Contents

Unpack the Time Stamp and check its contents to ensure that the Time Stamp and all accessories are included.

- User's manual x 1
- Key x 2
- Fuse (Ac 1A) x 1
- Wall-Mount: Screw x 4
- Template x 1

Structure of Time Stamp

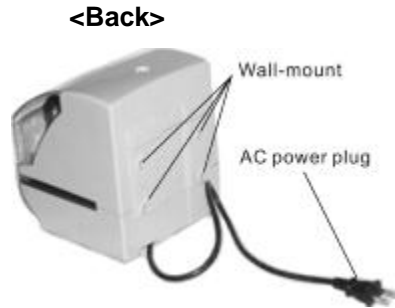

<Cover off>



Print position on Time card

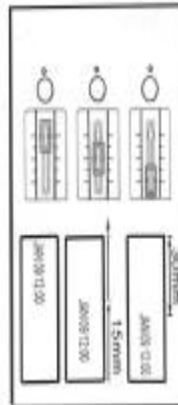

Print position from the card edge is adjustable by pressing and sliding the print position button located on the right outside bottom of the Time Stamp.

Maximum distance from edge of from to print is approximately 1 3/16" (30mm)

3. QUICK EASY SETUP

1. Unlock the key and remove the top cover.



3. Replace the cover and lock.



2. Remove the Protection Pad.



4. Plug the Ac cord into the Ac outlet and insert a card.

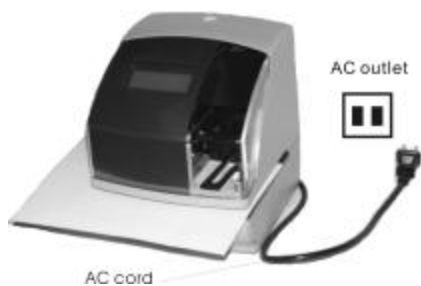

4. OPTIONAL FUNCTIONS

Following optional functions are available by adding an optional board.
External Time Signal for Bell, Built-in buzzer.

External Time Signal and Built-in Buzzer

External Time Signal and Built-in Buzzer shall be controlled by Time table program and their duration setting.

Refer to the “18. SETTING THE TIME TABLE PROGRAM”, and the “19. SETTING THE EXTERNAL TIME SIGNAL / BUILT-IN BUZZER”.

Connection specifications for External Time Signal contact

- Contact output: dry contact
- Contact capacity: 5A, 30V (Resistive)

5. SETTING THE TIME STAMP

To set the Time Stamp, you must plug the AC cord into the AC outlet and remove the cover. Then press the [F] button once, the Time Stamp goes into the program mode showing the “▲” on the display position under the “TIME” mark.

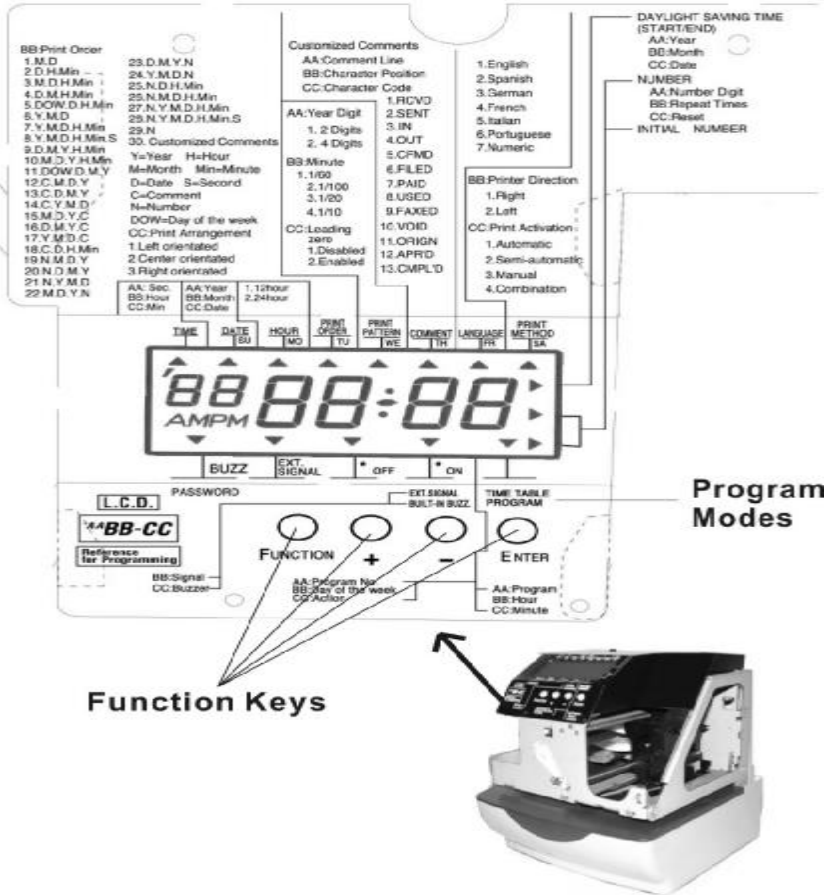

Function keys:

[F] (function) button: You can select the desired program setting by pressing this [F] button, Selected program setting mode is indicated by the “▲” on the display.

[+] button: When you press the [+] button, you can increment the set value.

[-] button: When you press the [-] button, you can decrement the set value.

[E] (enter) button: You can set the value selected on the display by pressing the [E] button.

6. SETTING THE TIME

Example: Change the time from PM 10:20 to AM 11:30

1. Press the [F] button, and position the “▲” under the “TIME” mark. The “Hour” flashes. (The flashing means it can be changed.)

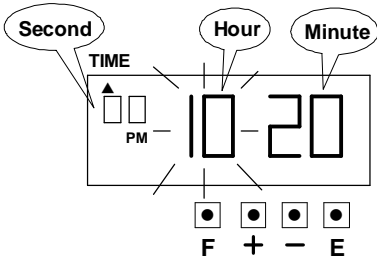

Setting the “hour”

Press the [+] or [-] button to set at “AM 11” and press [E] button. At the same time, the flashing changes from “Hour” to “Minute”.

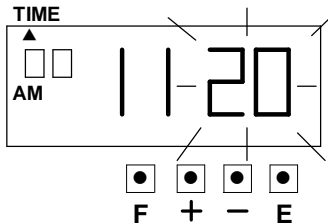

2. Setting the “Minute”

Press the [+] or [-] button to set at “30” and press [E] button.

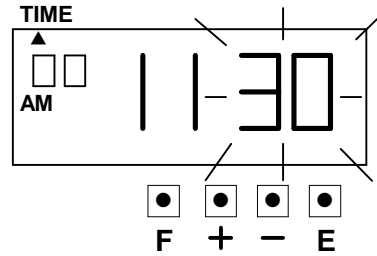

At the same time, the “Second” start to run from “00” and the LCD screen only display “▲” under the “TIME” mark.

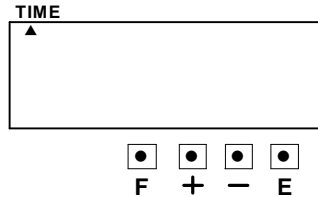

3. If you want to set another function, press the [F] button to continue setting.

If you finished setting the functions, press the [E] button again. The LCD screen will return to normal mode.

7. SETTING THE DATE

Example: Change the date from January 9, 2004 to OCT 10, 2004.

1. Press the [F] button, and position the “▲” under the “DATE” mark. The “Year” flashes. (The flashing means it can be changed.)

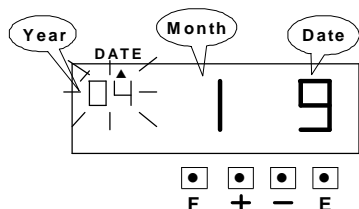

Setting the year

Such as example, press the [E] button because the year 2004 is not to be changed.

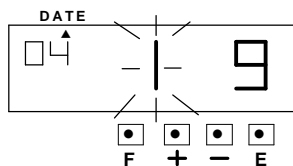

At the same time, the flashing changes from “Year” to “Month”.

2. **Setting the “Month”**

Press the [+] or [-] button to set at “10” and press [E] button. At the same time, the flashing changes from “Month” to “Date”.

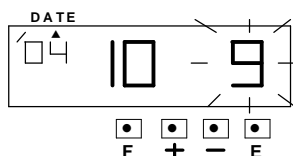

3. **Setting the “Date”**

Press the [+] or [-] button to set at “10” and press the [E] button.

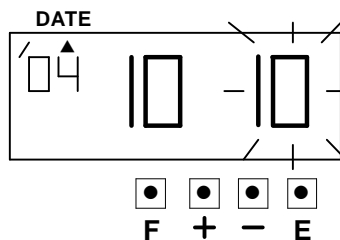

At the same time, the LCD screen only display “▲” under the “Date” mark.

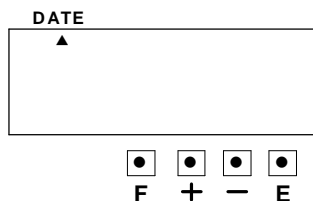

4. If you want to set another function, press the [F] button to continue setting.
If you finished setting the functions, press the [E] button again. The LCD screen will return to normal mode.

8. SETTING THE 12/24 HOUR FORMAT

Example: Setting the hour format to 24 hour.

1. Press the [F] button, and position the “▲” under the “Hour” mark. The flashing digit indicates “Hour Format Options”. (The flashing means it can be changed.)

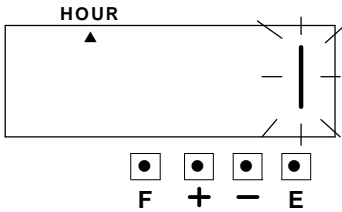

3. If you want to set another function, press the [F] button to continue setting.

If you finished setting the functions, press the [E] button again. The LCD screen will return to normal mode.

	Hour Format Options	Display
1	12 hour	PM 6:00
2	24 hour	18:00

2. Setting the hour format

Press the [+] or [-] button to set at “2”, and press [E] button.

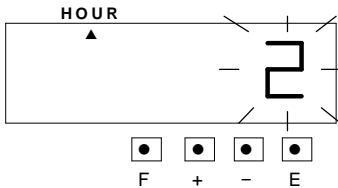

At the same time, the LCD screen only display “▲” under the “Hour” mark.

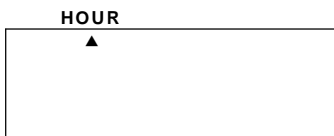

9. SETTING THE PRINT ORDER

Example: Set the print order to “Year, Month, Date, Hour and Minute”.

※ Please see page 10 for reference.

1. Press the [F] button, and position the “▲” under the “Print Order” mark. The flashing digit indicates “Print Order Options”. (The flashing digit means it can be changed.)

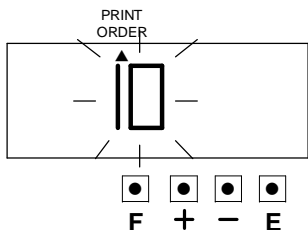

2. Setting the Print Order

Press the [+] or [-] button to set at “7”, and press [E] button.

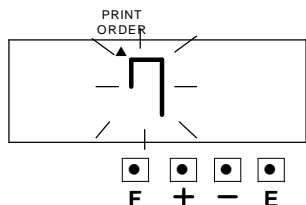

At the same time the LCD screen only display “▲” under the “PRINT ORDER” mark.

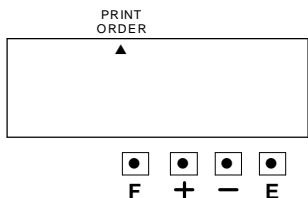

3. If you want to set another function, press the [F] button to continue setting.
If you finished setting the functions, press the [E] button again. The LCD screen will return to normal mode.

Y=Year, M=Month, D=Date, DOW=Day of the week, H=Hour, Min=Minute,

S=Second, C=Comment, N=Number

	Print Order Options	Print Example		Print Order Options	Print Example
1	M.D	JAN 31	16	D.M.Y.C	31 JAN '04 SENT
2	D.H.Min	31 10:00	17	Y.M.D.C	'04 JAN 31 SENT
3	M.D.H.Min	JAN 31 10:00	18	C.D.H.Min	SENT 31 10:00
4	D.M.H.Min	31 JAN 10:00	19	N.M.D.Y	123456 JAN 31 '04
5	DOW.D.H.Min	FR, 31 10:00	20	N.D.M.Y	123456 31 JAN '04
6	Y.M.D	'04 JAN 31	21	N.Y.M.D	123456 '04 JAN 31
7	Y.M.D.H.Min	'04 JAN 31 10:00	22	M.D.Y.N	JAN 31 '04 123456
8	Y.M.D.H.Min.S	'04 JAN 31 10:00:00	23	D.M.Y.N	31 JAN '04 123456
9	D.M.Y.H.Min	31 JAN '04 10:00	24	Y.M.D.N	'04 JAN 31 123456
10	M.D.Y.H.Min	JAN 31 '04 10:00	25	N.D.H.Min	123456 31 10:00
11	DOW.D.M.Y	FR, 31 JAN '04	26	N.M.D.H.Min	123456 JAN 31 10:00
12	C.M.D.Y	SENT JAN 31 '04	27	N.Y.M.D.H.Min	123456 '04 JAN 31 10:00
13	C.D.M.Y	SENT 31 JAN '04	28	N.Y.M.D.H.Min.S	123456 '04 JAN 31 10:00:00
14	C.Y.M.D	SENT '04 JAN 31	29	N	123456
15	M.D.Y.C	JAN 31 '04 SENT	30	Customized Comment	

10. SETTING THE PRINT PATTERN

In this function, the printing of Year digit, the printing type of minute, and change of Leading Zero can be set.

Example: Setting the Year imprint to 4 digits, the minute to 1/100 min, and the Leading Zero to enabled.

1. Press the [F] button, and position the "▲" under the "PRINT PATTERN" mark. The flashing digit indicates "Year Digit". (The flashing means it can be changed.)

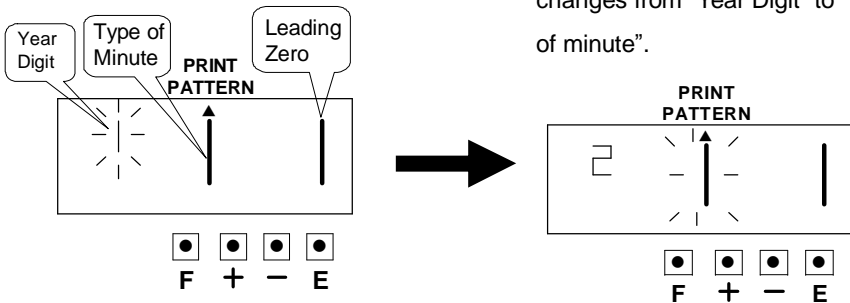

Setting the "Year Digit"

Such as example, Press the [+] or [-] button to set at "2" and press the [E] button.

At the same time, the flashing changes from "Year Digit" to "Type of minute".

	Year Digit Options	Print example
1	2 Digit	JAN 09 '04 11:30
2	4 Digit	JAN 09 2004 11:30

2. Setting the “Type of minute”

Press the [+] or [-] button to set at

“2”, and press the [E] button.

At the same time, the flashing changes from “Type of minute” to “Leading Zero”.

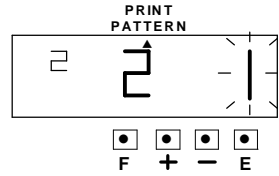

	Type of Minute	Print example
1	1/60	JAN 09 2004 11:10
2	1/100	JAN 09 2004 11.17
3	1/20 (=5/100)	JAN 09 2004 11.15
4	1/10	JAN 09 2004 11.1

3. Setting the “Leading Zero”

Press the [+] or [-] button to set at “2”, and press the [E] button.

Then the LCD screen only display “▲” under the “PRINT PATTERN” mark.

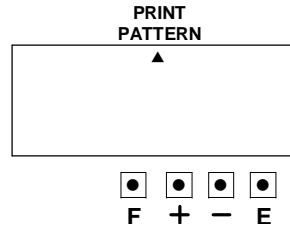
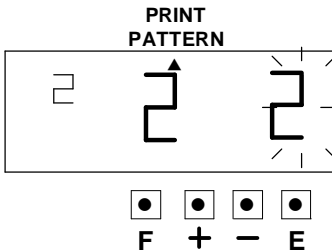

	Leading Zero	Print example
1	Zero Disable	JAN 9 3:00
2	Zero Enable	JAN 09 03:00

4. If you want to set another function, press the [F] button to continue setting. If you finished setting the functions, press the [E] button again. The LCD screen will return to normal mode.

11. SETTING THE PREPROGRAMMED COMMENTS

Example: Setting the comment to “SENT”

1. Press the [F] button, and position the “▲” under the “COMMENT” mark. The flashing digit indicates “Comment Options”. (The flashing means it can be changed.)

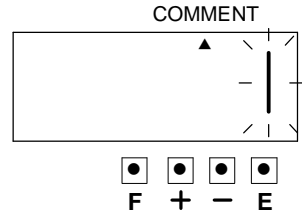

Setting the “Comment”

Such as example, Press the [+] or [-] button to set at “2”, and press the [E] button. Then the LCD screen only display “▲” under the “COMMENT” mark.

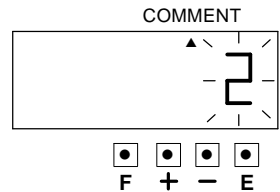

	Comment Options	Print Example
1	RCVD	JAN 09 '04 RCVD
2	SENT	JAN 09 '04 SENT
3	IN	JAN 09 '04 IN
4	OUT	JAN 09 '04 OUT
5	CFMD (Confirmed)	JAN 09 '04 CMFD
6	FILED	JAN 09 '04 FILED
7	PAID	JAN 09 '04 PAID
8	USED	JAN 09 '04 USED
9	FAXED	JAN 09 '04 FAXED
10	VOID	JAN 09 '04 VOID
11	ORIGN (Original)	JAN 09 '04 ORIGN
12	APR'D (Approved)	JAN 09 '04 APR'D
13	CMPL'D (Completed)	JAN 09 '04 CMPL'D

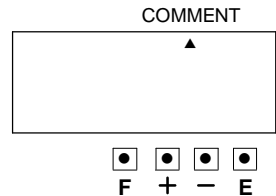

2. If you want to set another function, press the [F] button to continue setting. If you finished setting the functions, press the [E] button again. The LCD screen will return to normal mode.

12. SETTING THE CUSTOMIZED COMMENTS

* Maximum 3 lines comment can be set to print.

* This time stamp can print 31 characters (161 font size) at maximum, however number of characters will depend on font size. Refer to the “24. CHARACTER CODE FOR ALPHANUMBERIC”.

Example:

```

SPACE
CFH ▲HOTEL ----- 1st comment line
09 ▲JAN ▲'04 ----- 2nd comment line (Date, Month, Year)
LONDON ----- 3rd comment line
  
```

1. Press the [F] button, and position the “▲” under the “PRINT ORDER” mark. The flashing digit indicates “Print Order Options”. (The flashing means it can be changed.)

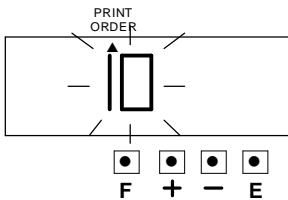

Press the [+] or [-] button to set at “30” (Customized Comment).

At the same time, a digit for “Print Position” appears next to “Print Order Options”.

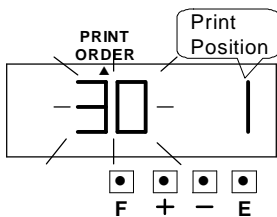

2. Press the [E] button. At the same time, the flashing digit changes from “Print Order Option” to “Print Position”.

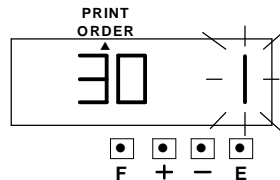

Such as example, press the [+] or [-] button to set at “1” and press [E] button, at the same time the LCD screen only display “▲” under the “Print Order” mark.

	PRINT POSITION
1	Left Orientated
2	Center Orientated
3	Right Orientated

3. Press the [F] button, and position the “▲” under the “COMMENT” mark.

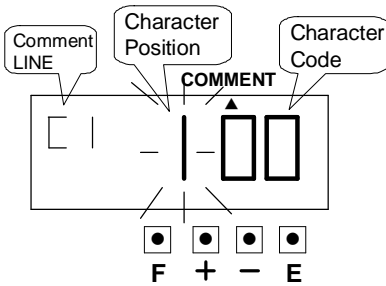

Setting the 1st comment line.

The flashing digit indicates “Character Position”. Press the [E] button .

At the same time, the flashing changes from “Character Position” to “Character Code”.

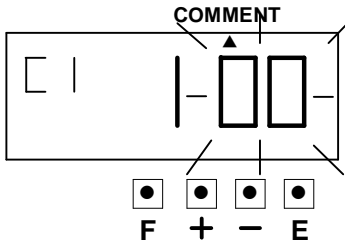

4. Setting the “Character Code”

Such as example, the 1st character is “C”, press the [+] or [-] button to set at “04”, and press the [E] button.

Refer to the
“24. CHARACTER CODE FOR ALPHANUMBER”

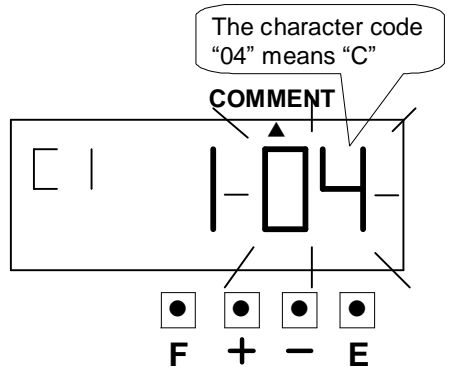

At the same time, the “Character Position” changes from the 1st character to the 2nd character.

The flashing digit indicates “Character Position”.

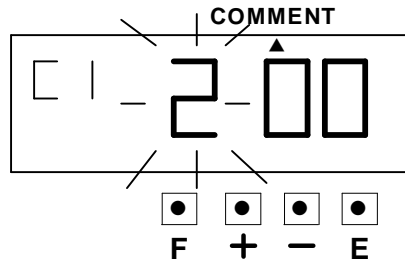

Press the [E] button, then the flashing changes from “Character Position” to “Character Code”.

5. The 2nd character is “F”, press the [+] or [-] button to set at “07”, and press [E] button.

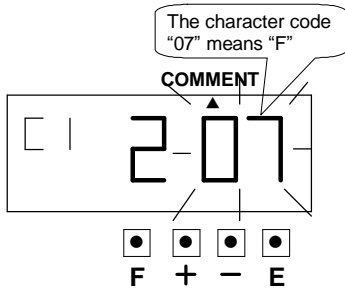

At the same time, the “Character Position” changes from the 2nd character to the 3rd character.

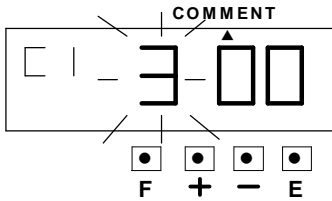

Press the [E] button, then the flashing changes from “Character Position” to “Character Code”.

6. The 3rd character is “H”, press the [+] or [-] button to set at “09”, and press [E] button.

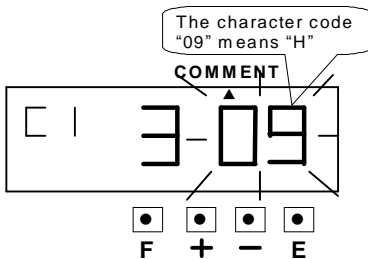

7. Follow the same procedure for further characters settings.

8. Setting the 2nd comment line

Press the [E] button to change the comment line number to “C2”.

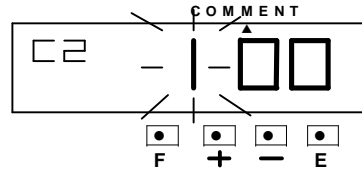

Such as example, the 1st character is “DATE”, press the [+] or [-] button to set at “28”, and press the [E] button.

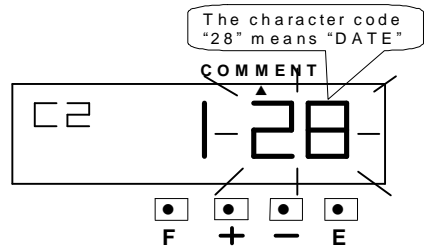

At the same time, the “Character Position” changes from the 1st character to the 2nd character.

The flashing digit indicates “Character Position”.

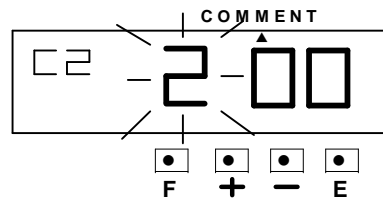

Press the [E] button, then the flashing changes from “Character Position” to “Character Code”.

9. The 2nd character is "SPACE", then press the [+] or [-] button to set at "01", and press the [E] button.

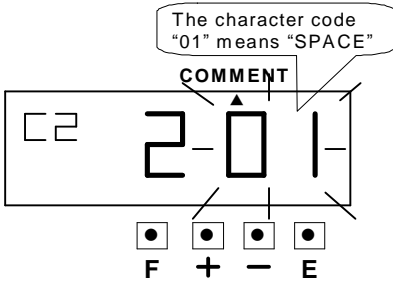

At the same time, the "Character Position" changes from the 2nd character to the 3rd character.

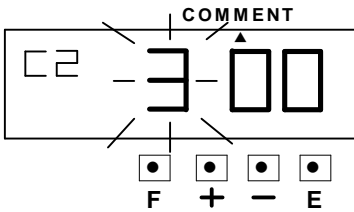

Press the [E] button, then the flashing changes from "Character Position" to "Character Code".

10. The 3rd character is "MONTH", then press the [+] or [-] button to set at "27", and press the [E] button.

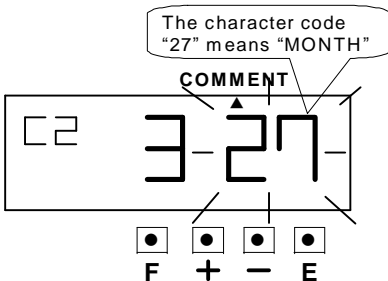

11. Follow the same procedure for further characters settings.

12. Setting the 3rd comment line

Press the [E] button to change the comment line number to "C3".

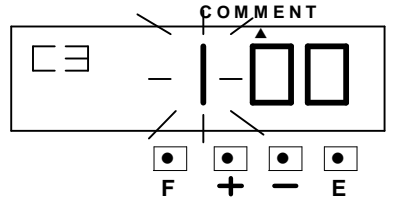

Such as example, the 1st character is "L", press the [+] or [-] button set at "0d", and press the [E] button.

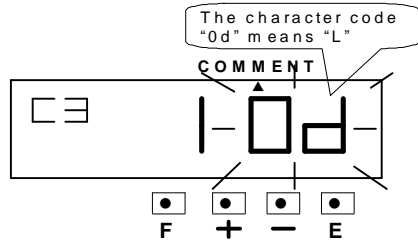

At the same time, the "Character Position" changes from the 1st character to the 2nd character.

The flashing digit indicates "Character Position".

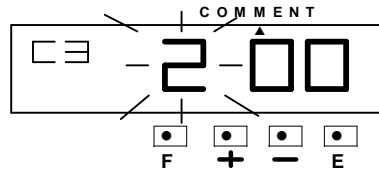

Press the [E] button, then the flashing changes from "Character Position" to "Character Code".

13. The 2nd character is “O”, then press the [+] or [-] button to set at “10”, and press [E] button.

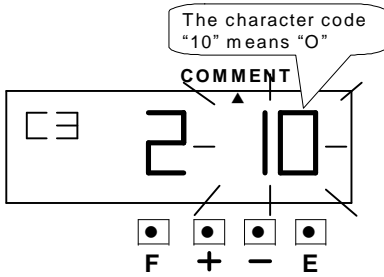

At the same time, the “Character Position” changes from the 2nd character to the 3rd character. Press the [E] button, then the flashing changes from “Character Position” to “Character Code”.

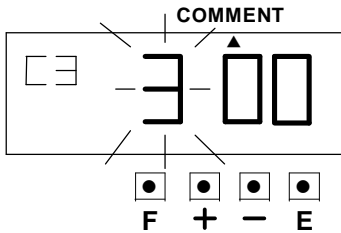

14. Set the last character “N” in the same manner as above.

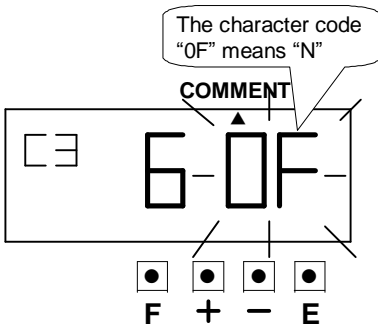

15. After you finished setting the customized comments, press the [E] button again, the LCD screen will return to normal mode.

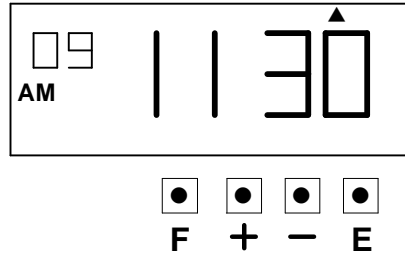

HOW TO CORRECT CUSTOMIZED COMMENTS

Use below character code correction

Code	Meaning
F8	Insert Character
F9	Delete Character
FA	Insert Line
Fb	Delete Line
FC	Exchange Line 1 to 2
Fd	Exchange Line 2 to 3
FE	Exchange Line 1 to 3
FF	Delete All

Setting the Print Position of Customized Comments

Left orientated

CFH HOTEL
09 JAN '04
LONDON

Center orientated

CFH HOTEL
09 JAN '04
LONDON

Right orientated

CFH HOTEL
09 JAN '04
LONDON

Example: Change the print position to “Right orientated”.

1. Press the [F] button, and position the “▲” under the “PRINT ORDER” mark.

At the same time, the flashing digit indicates “Print Order Options”.
(The flashing digit means it can be changed.)

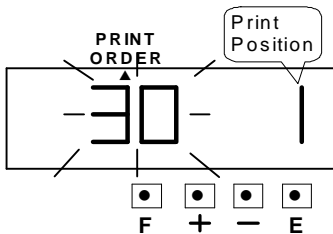

Press the [E] button because the “Print Order Options” is not to be changed. At the same time, the flashing digit indicates “Print Position”.

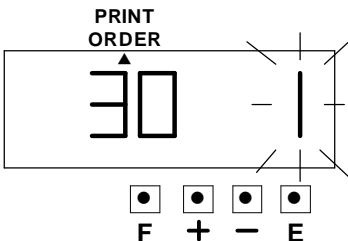

2. Change the “Print Position”

Press the [+] or [-] to set at “3”, and then press the [E] button.

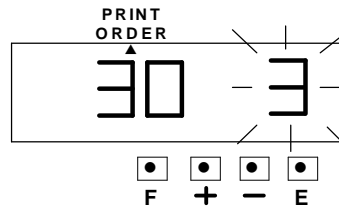

At the same time, the LCD screen only display “▲” under the “PRINT ORDER” mark.

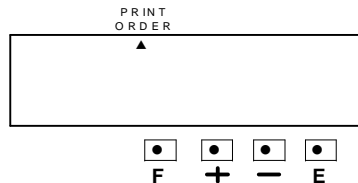

3. After you finished setting the print order and print position setting . Press the [E] button again, the LCD screen will return to normal mode.

	Print position
1	Left orientated
2	Center orientated
3	Right orientated

Confirming and Change the Customized Comments

Example: 1st comment line: No change.

2nd comment line: Change from year to time "HH:MM".

3rd comment line: No change.

CFH HOTEL	→	CFH HOTEL
09 JAN '04	→	09 JAN <u>12</u> : 00
LONDON		LONDON

Change from year to time

1. Confirming the 1st comment line

Press the [F] button, and position the "▲" under the "COMMENT" mark.

At the same time the "Character Position" flashes, and press [+] button.

While the "Character Position" changes, the "Character Code" that has been set appears.

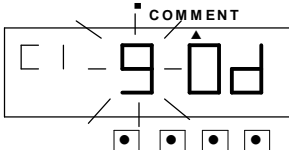
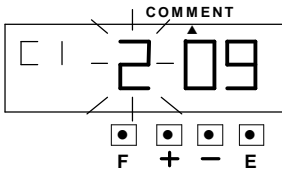
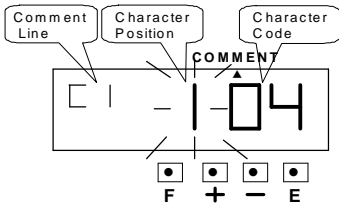

Finally, the display changes to the following figure.

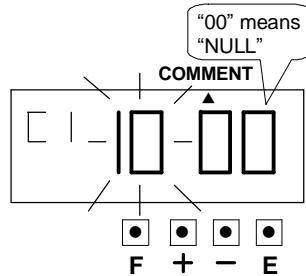

At this time, press the [E] button twice, and the 2nd comment line is displayed.

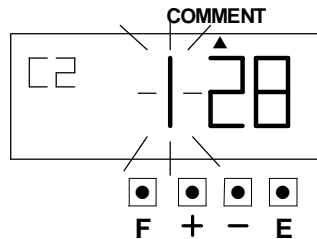

2. Changing the Customized Comments

Such as example, press the [+] or [-] button to set at "5", and then press the [E] button. At this time, flashing changes from the "Character Position" to the "Character Code".

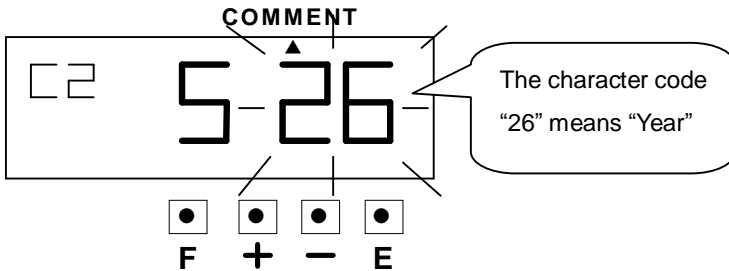

Press the [+] or [-] button to set at "2A".

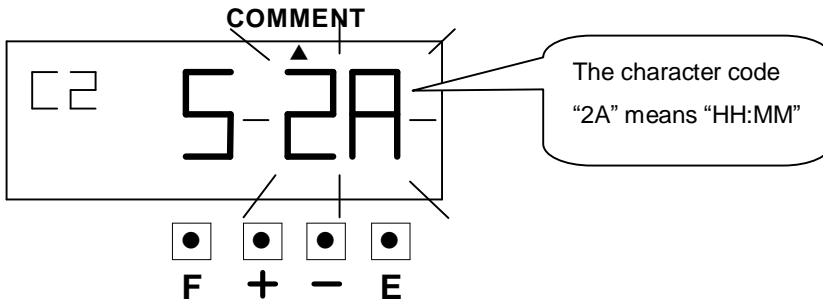

Then press the [E] button once.

Now changing the character code has been completed.

3. Confirming the 3rd comment line

Confirming the 3rd comment line in the same manner as step 1 (Confirming the 1st comment line)

4. After you finished confirming and changing the customized comments, press the [E] button again, the LCD screen will return to normal mode.

13. SETTING THE LANGUAGE

This function is available if you select “Month”, “Day of the week” or “Comment” in previous “PRINT ORDER”.

Example: Change the print language to French.

1. Press the [E] button and position the “▲” under the “LANGUAGE” mark.
At the same time, the flashing digit indicates “Print Language Options”.
(The flashing means it can be changed.)

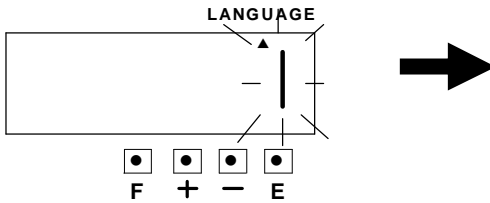

Change the “Language”

Such as example, press the [+]- or [-] button to set at “4”, and then press [E] button.

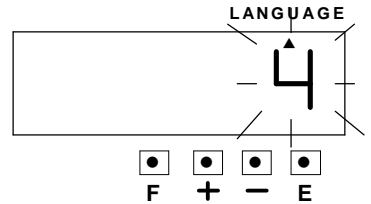

At the same time, the LCD screen only display “▲” under the “LANGUAGE” mark.

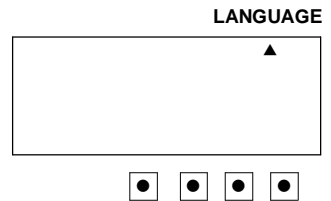

	Print Language Option	Print Example
1	ENGLISH	MO, 11 OCT '04 IN 11 09:00
2	SPANISH	LU, 11 OCT ,04 ENT 11 09:00
3	GERMAN	MO, 11 OKT '04 EING 11 09:00
4	FRENCH	LU, 11 OCT ,04 ENTR 11 09:00
5	ITALIAN	LU, 11 OTT ,04 ENT 11 09:00
6	PORTUGUESE	SG, 11 OUT ,04 ENTR 11 09:00
7	NUMERIC	1, 11-10 '04 OUT 11 09:00

2. After you finished setting the language, press the [E] button again, the LCD screen will return to normal mode.

14. SETTING THE PRINT METHOD

Example: Change the print direction to “Left” and the print activation to “Combination”.

1. Press the [F] button and position the “▲” under the “PRINT METHOD”
At the same time, the flashing digit indicates “Print Direction Option”

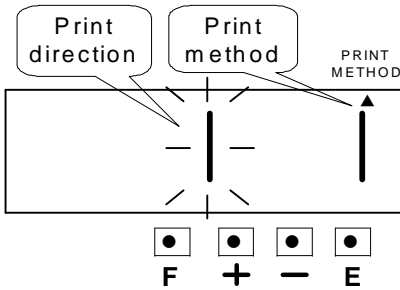

	Print Direction Options
1	Right
2	Left

Change the Print Direction

Such as example, press the [+] or [-] button to set at “2”, and then press the [E] button.

At the same time, the flashing changes from “Print Direction” to the “Print Activation”.

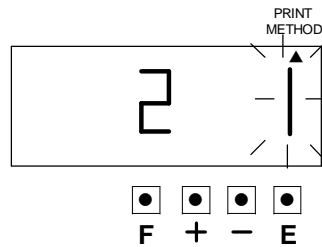

2. Change the “Print activation”

Such as example, press [+] or [-] button to set at “4”, and then press [E] button.
At the same time, the LCD screen only display “▲” under the “PRINT METHOD” mark.

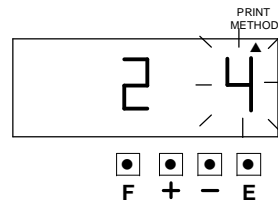

	Print Activation Options
1	Automatic
2	Semi- Automatic
3	Manual
4	Combination

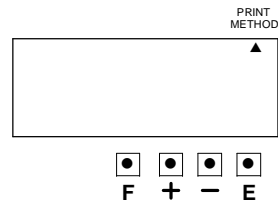

3. After you finished setting the language, press the [E] button again, the LCD screen will return to normal mode.

Automatic: Time stamp to print by simply inserting a card or piece of paper.

Semi-automatic: Time stamp to print by pressing the push bar only when a card or piece of paper is inserted.

Manual: Time stamp to print by pressing the push bar.

Combination: Time stamp to print by pressing the push bar or inserting a card or piece of paper.



15. SETTING THE DAYLIGHT SAVING TIME

✘ At 2:00 AM on the first day of summer time, the clock automatically gains one hour to show 3:00 AM.

At 3:00 AM on the last day of summer time, the clock automatically loses one hour to show 2:00 Am.

✘ SETTING THE DAYLIGHT SAVING TIME

Example:

The first day of summer time: Sunday, March 28, 2004

The last day of summer time: Sunday, September 26, 2004.

If set as the above, the unit remembers the start date as the last Sunday of March and the end date as the last Sunday of October.

Once set, the unit automatically updates the setting every year thereafter. No further manual setting is necessary.

✘ Two programs (starting and ending day) that must be set.

1. Press the [F] button and position the “▲” next to the “DAYLIGHT SAVING TIME” mark. (The flashing means it can be changed.)

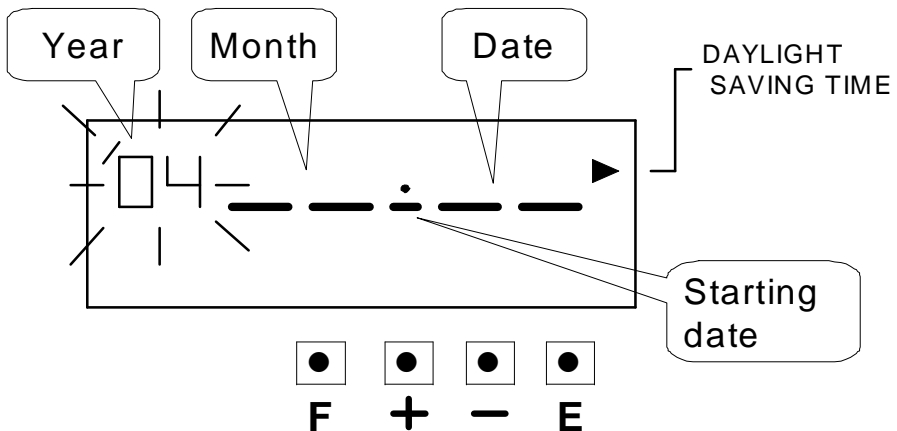

Set the starting date

2. Setting the “Year”

Such as example, press the [E] button because the year 2004 is not to be changed.

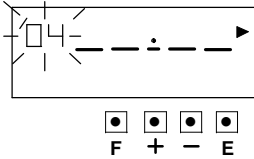

At the same time, the flashing changes from “Year” to “Month”.

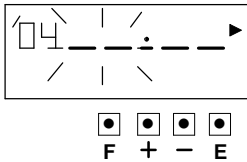

3. Setting the “Month”

Press the [+] or [-] button to set at “03”, and press the [E] button.

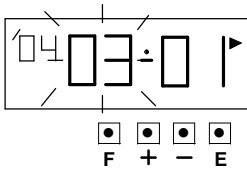

At the same time, the flashing changes from “Month” to “Date”.

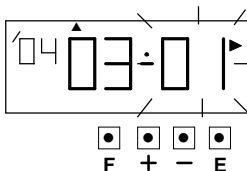

4. Setting the “Date”

Press the [+] or [-] button to set at “28”, and press the [E] button.

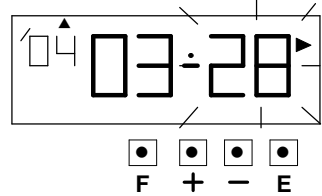

After a few seconds, go on to set “the ending date”.

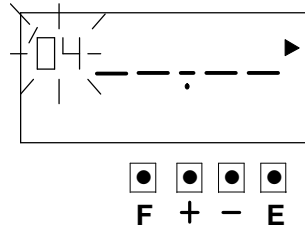

Set the ending date

5. Setting the “Year”

Such as example, press the [E] button because the year 2004 is not to be changed.

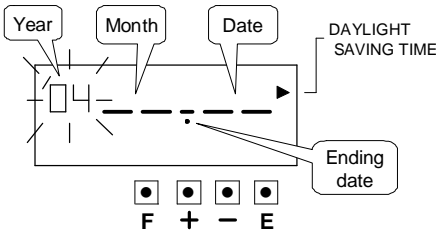

At the same time, the flashing changes from “Year” to “Month”.

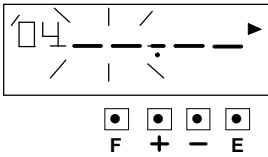

6. Setting the “Month”

Press the [+] or [-] button to set at “09”, and press the [E] button.

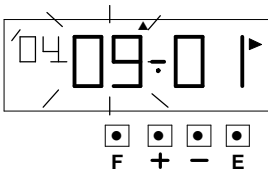

At the same time, the flashing changes from “Month” to “Date”.

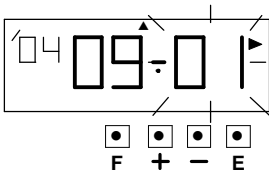

7. Setting the “Date”

Press the [+] or [-] button to set at “26”, and press the [E] button.

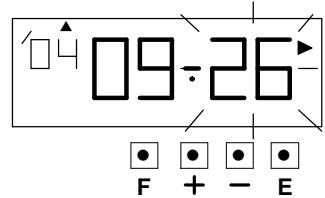

At the same time, the LCD screen stop flashing,

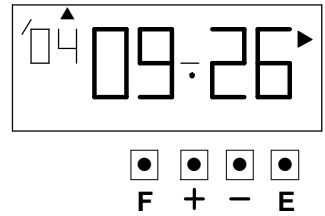

After you finished setting the daylight saving time, press the [E] button again, the LCD screen will return to normal mode.

Deleting the Daylight Saving Time setting

To delete the daylight saving time setting, change the display of “month” of the starting setting to “- -”.

Example: To delete the daylight saving time setting.

1. Press the [F] button and position the “▲” next to the “DAYLIGHT SAVING TIME” mark. (The flashing means it can be changed.)

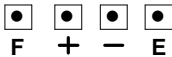
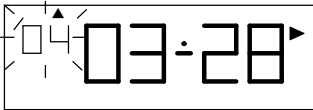

2. Press the [E] button, and then the flashing changes from “Year” to “Month”

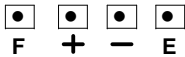
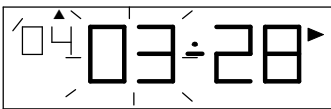

3. Press the [+] or [-] button to set the “Month” and “Date” at “- -”.

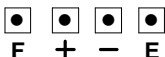
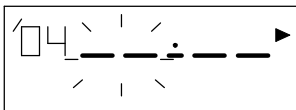

Press the [E] button twice. At the same time, the LCD screen stop flashing, the daylight saving time setting has been deleted.

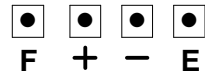
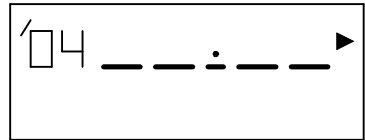

4. After you finished deleting the daylight saving time, press the [E] button again, the LCD screen will return to normal mode.

16. SETTING THE NUMBER

This function, you can set up the digits of printed number, the Repeat Time of number, and type of Number reset.

Example: set up the Number Digit to 5 digits and the repeat times to 1 time, and the reset to 0.

1. Press the [F] button and position the “▲” next to the “NUMBER” mark. (The flashing means it can be changed.)

Setting the “Number Digit”

The Number Digit can be set 1 to 8.

Such as example, press the [+] or [-] button to set at “5”, and then press the [E] button.

At the same time, the flashing changes from The “Number Digit” to “Repeat Times”.

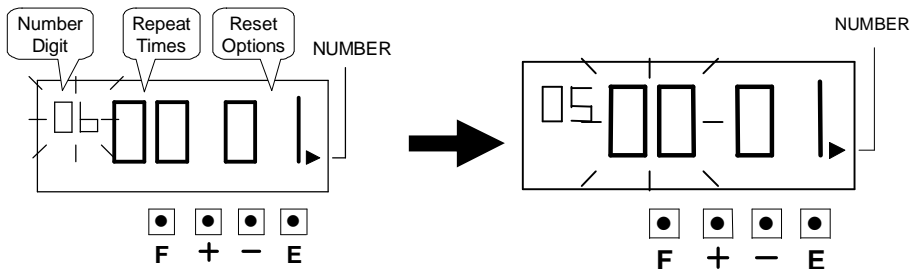

Printing example: 6 Digit of Number —————> 123456 JAN 9 '04

5 Digit of Number —————> 12345 JAN 9 '04

2. Setting the “Repeat Times”

The Repeat Times can be set to 0 to 9.

Press [+] or [-] button to set at “1”, and then press the [E] button.

At the same time, the flashing changes from the “Repeat Times” to “Reset Options”.

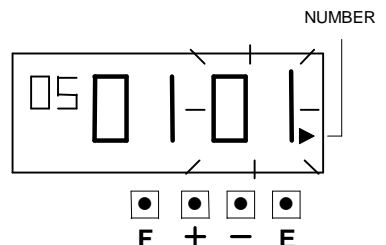

Print example:

0 time repeat

1st time 12345 JAN 9 '04

2nd time 12345 JAN 9 '04

3rd time 12345 JAN 9 '04

4th time 12345 JAN 9 '04

⋮

⋮

01time repeat

1st time 12345 JAN 9 '04

2nd time 12346 JAN 9 '04

3rd time 12347 JAN 9 '04

4th time 12348 JAN 9 '04

⋮

⋮

3. Setting the “Reset Options”

Press [+] or [-] button to set at “3”, and then press the [E] button.

At the same time, the LCD screen only display “▲” next to the “NUMBER” mark.

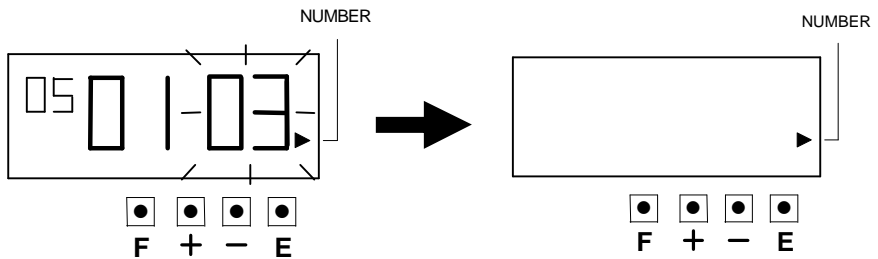

	Rest Options	Execution event of Reset
1	Disable	_____
2	Return to initial number	Change of date
3	Return to 0	Change of date

4. After you finished setting the Number, press the [E] button again, the LCD screen will return to normal mode.

17. SETTING THE INITIAL NUMBER

※Up to 8 digit can be set, however the number of digits for “Initial Number” depends on how you set the “Number”.

Example: setting the initial number to “100”.

Refer “16. SETTING THE NUMBER”

1. Press the [F] button and position the “▲” next to the “INITIAL NUMBER” mark.
At the same time, the flashing “-” indicates the 1st digit of the initial number.
(The flashing means it can be changed.)

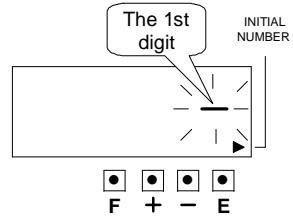

2. Press [+] or [-] button to set at “1”, and then press the [E] button.
At the same time, the 2nd of “Initial Number” appears next to “1” (the 1st digit).

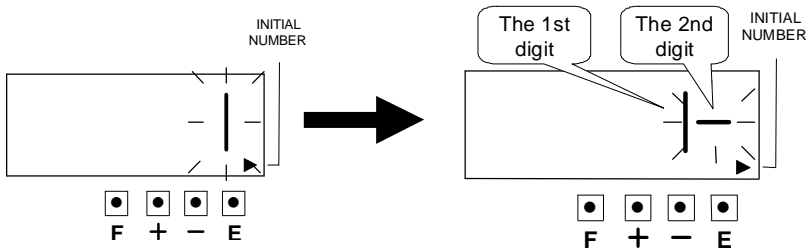

3. Set the correct numbers in the same manner as step 2, and then press the [E] button.
When the 3rd “Number Digit” has been set at “0”, then press the [E] button.

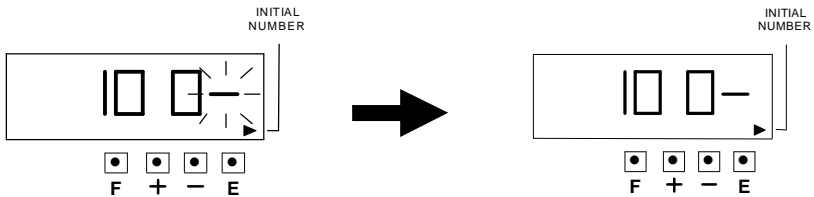

4. After you finished setting the Number, press the [E] button again, the LCD screen will return to normal mode.

18. SETTING THE TIME TABLE PROGRAM

This function allow special mark “★” printing, an External Time Signal (optional) and a Built-in buzzer (optional). These functions can be programmed for each day of the week and each time period.

※Up to 48 programs can be set (Program No.1 Through No.48).

※The “Ext. signal” and the “Built-in buzzer” are available only when “Optional PC board” is connected to the time stamp.

Code for Day of the week

	Day of the week		Day of the week
1	Monday only	6	Saturday only
2	Tuesday only	7	Sunday only
3	Wednesday only	8	Monday to Friday
4	Thursday only	9	Monday to Saturday
5	Friday only	10	Every day

Code for Action

	Action
1	Special mark “★” on
2	Special mark “★” off
3	Ext. signal on
4	Built-in buzzer on

Example: Monday to Friday 09:01 ~ 18:00 Special mark “★” on.

Monday to Friday 09:00 Ext. signal on

Monday to Friday 18:00 Built-in buzzer on

1. Press the [F] button and position the “▲” over the “Time table program” mark.
At the same time, the flashing digit indicates “Program No.”.

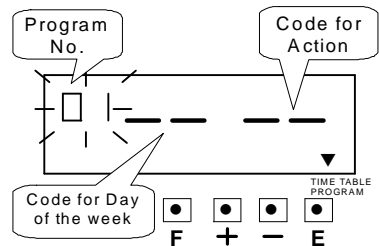

2. Setting program No.1 (Special mark “★” on)

(1) Setting the code for “Day of the week”.

Press the [E] button, and then the Program No. is entered. At the same time, the flashing changes from the “Program No.” to the “Code for Day of the week”.

Such as example, press the [+] or [-] button to set at “8”, and then press [E] button. At the same time the flashing changes from “Code for Day of the week” to the “Code for Action”.

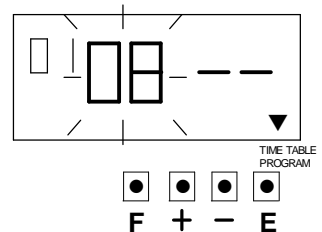

(2) Setting the Code for “Action”

Press the [+] or [-] button to set at “1”, and then press the [E] button. At the same time, the display changes to the following figure.

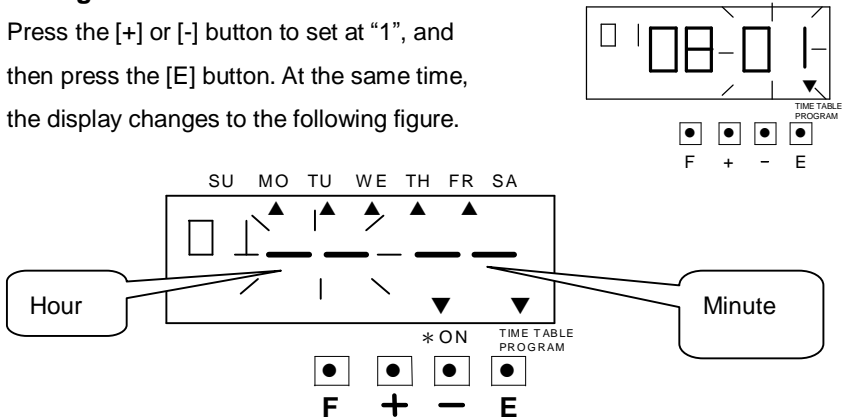

(3) Setting the “Hour”

Press the [+] or [-] button to set at “9”, and then press the [E] button.

At the same time, the flashing changes from the “Hour” to the “Minute”.

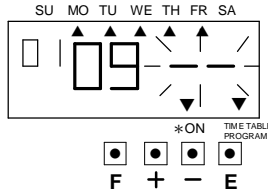
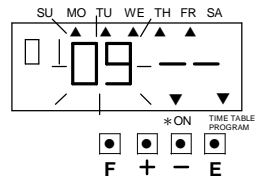

(4) Setting the “Minute”

Press the [+] or [-] button to set at “01”, and then press the [E] button.

At the same time, the display changes to the following figure.

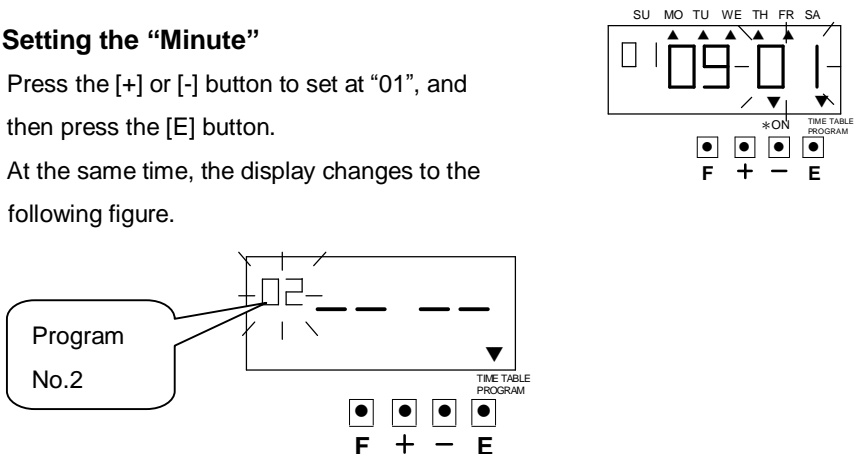

3. Setting program No.2 (Special mark “★” off)

(1) Setting the code for “Day of the week”.

Press the [E] button, and then the Program No. is entered. At the same time, the flashing changes from the “Program No.” to the “Code for Day of the week”.

Such as example, press the [+] or [-] button to set at “8”, and then press [E] button. At the same time the flashing changes from “Code for Day of the week” to the “Code for Action”.

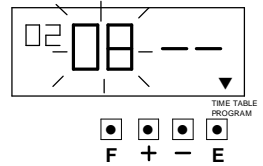

(2) Setting the Code for “Action”

Press the [+] or [-] button to set at “2”, and then press the [E] button. At the same time, the display changes to the following figure.

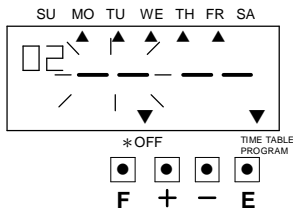
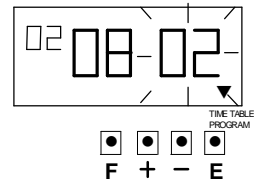

(3) Setting the “Hour”

Press the [+] or [-] button to set at “18”, and then press the [E] button.

At the same time, the flashing changes from the “Hour” to the “Minute”.

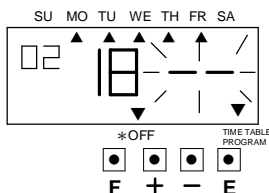
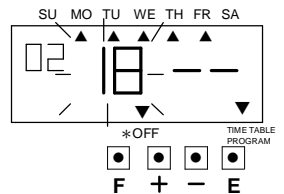

(4) Setting the “Minute”

Press the [+] or [-] button to set at “01”, and then press the [E] button.

At the same time, the display changes to the following figure.

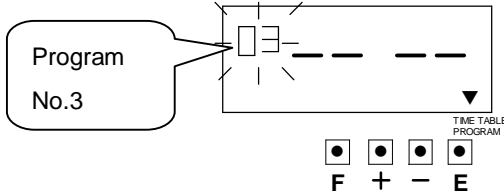
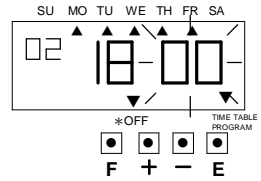

4. Setting program No.3 (Ext. signal on)

(1) Setting the code for “Day of the week”.

Press the [E] button, and then the Program No. is entered. At the same time, the flashing changes from the “Program No.” to the “Code for Day of the week”.

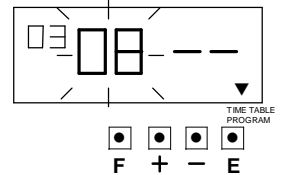

Such as example, press the [+] or [-] button to set at “8”, and then press [E] button. At the same time the flashing changes from “Code for Day of the week” to the “Code for Action”.

(2) Setting the Code for “Action”

Press the [+] or [-] button to set at “3”, and then press the [E] button. At the same time, the display changes to the following figure.

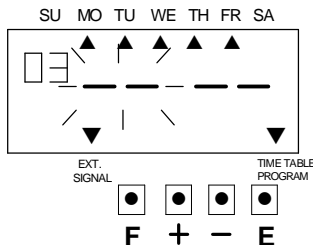
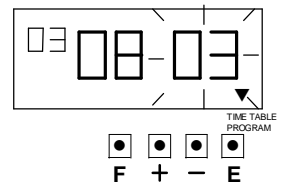

(3) Setting the “Hour”

Press the [+] or [-] button to set at “09”, and then press the [E] button.

At the same time, the flashing changes from the “Hour” to the “Minute”.

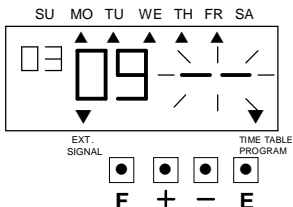
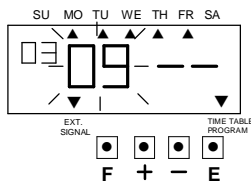

(4) Setting the “Minute”

Press the [+] or [-] button to set at “00”, and then press the [E] button.

At the same time, the display changes to the following figure.

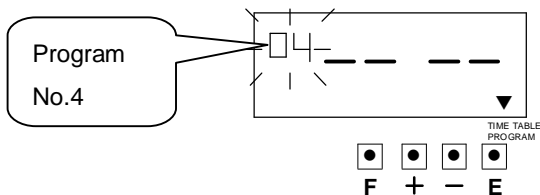
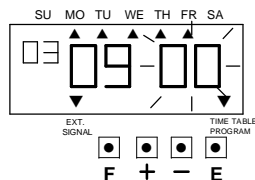

4. Setting program No.4 (Built-in Buzzer on)

(1) Setting the code for “Day of the week”.

Press the [E] button, and then the Program No. is entered. At the same time, the flashing changes from the “Program No.” to the “Code for Day of the week”.

Such as example, press the [+] or [-] button to set at “8”, and then press [E] button. At the same time the flashing changes from “Code for Day of the week” to the “Code for Action”.

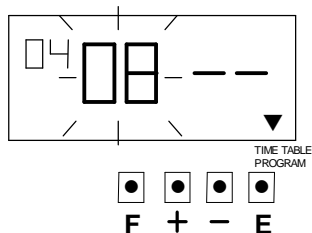

(2) Setting the Code for “Action”

Press the [+] or [-] button to set at “4”, and then press the [E] button. At the same time, the display changes to the following figure.

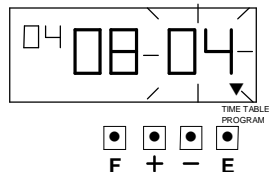
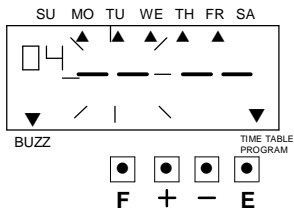

(3) Setting the “Hour”

Press the [+] or [-] button to set at “18”, and then press the [E] button.

At the same time, the flashing changes from the “Hour” to the “Minute”.

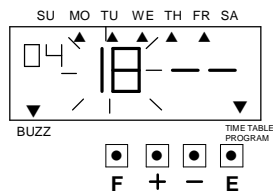
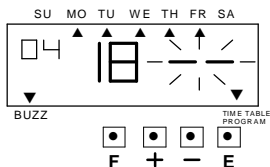

4) Setting the “Minute”

Press the [+] or [-] button to set at “00”, and then press the [E] button.

At the same time, the display changes to the following figure.

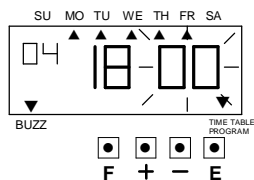
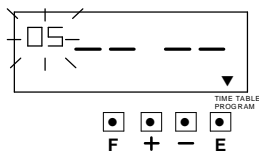

4. After you finished setting the “Time Table Program”, press the [E] button four times, the LCD screen will return to normal mode.

Confirming the Time Table Program settings

To confirm the programs that has been set, press the [F] button and position the “▲” over the “Time Table Program” mark. At the same time, the “Program No.” flashes, and then press the [E] button. After you finished confirming the program, press the [E] button four times, the LCD screen will return to normal mode.

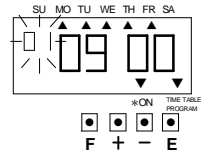

Deleting the time table program setting

Example: Deleting the “Program No.3”

- To delete a program, set the “Program No.” to flash, and press the [+] or [-] button until the desired program No. appeared, and then press the [E] button.

At the same time, the display changes to the following figure.

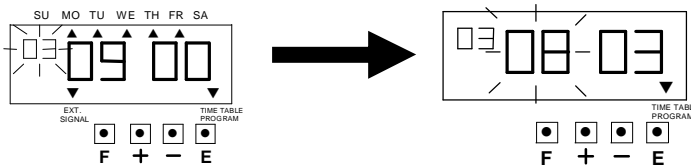

- Press the [+] or [-] button to set at “--”, and then press the [E] button, the display changes to the following figure.

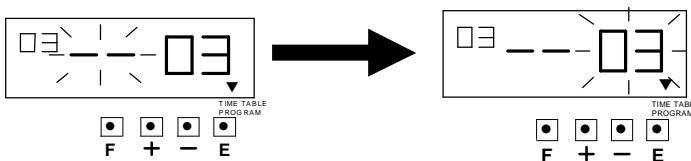

- Press the [+] or [-] button to set at “--”, and then press the [E] button, the display changes to the following figure.

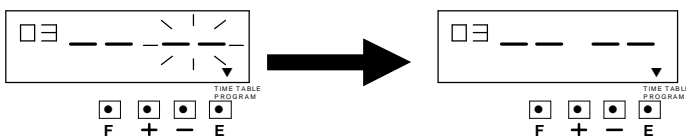

- After you finished deleting the “Time Table Program”, press the [E] button again, the LCD screen will return to normal mode.

19. SETTING THE EXTERNAL TIME SIGNAL /BUILT-IN BUZZER

This function is to set the durations of External Time Signal and Built-in Buzzer. For the number of seconds, 1 through 59 can be selected.

※For this feature to be functional, the optional pc board must be connected to the Time stamp.

Example: Setting the External Time signal to 10 seconds and Built-in Buzzer to 15 seconds.

1. Press the [F] button and position “▲” over the “EXT. SIGNAL / BUILT-IN BUZZER” mark.
At the same time, the flashing digit indicates the “Ext. Signal”.

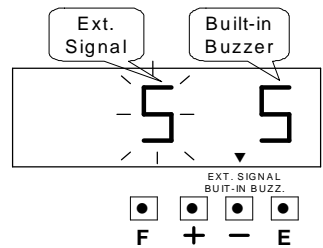

2. Setting the durations of “Ext. Signal”

Such as example, Press the [+] or [-] button to set at “10”, and then press the [E] button.
At the same time, the flashing changes from the “Ext. Signal” to “Built-in Buzzer”.

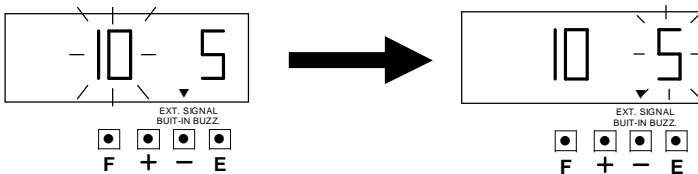

3. Setting the durations of “Built-in Buzzer”

Such as example, Press the [+] or [-] button to set at “15”, and then press the [E] button.

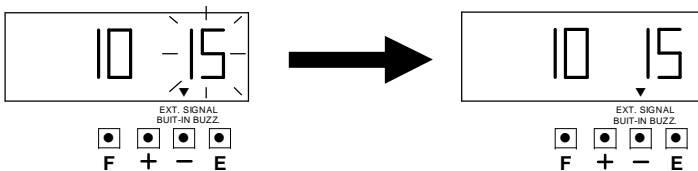

4. After you finished setting the external signal / built buzzer, press the [E] button again, the LCD screen will return to normal mode.

20. SETTING THE PASSWORD

If the password is set. When you are setting the time stamp, the time stamp ask to you enter the password. If the password you entered does not coincide with the setting, you can not change the setting values.

※You may set a password by any four digit number from 0001 to 9998.

※Number “0000” and “9999” can not be used as password.

※Please reset all settings when you forgot the password. Refer to the “22. RESETTING”

Registering the Password

Example: Set the password “0109”.

1. Press the [F] button and position the “▲” the “PASSWORD” mark.

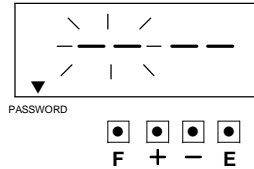

Setting the first two digit

Such as example, press the [+] or [-] button to set at “01”, and then press the [E] button. The display changes to the following figure.

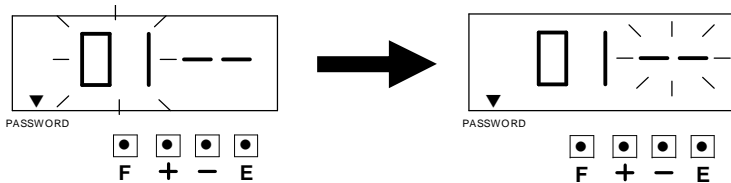

2. **Setting the second two digit**

Such as example, press the [+] or [-] button to set at “09”, and then press the [E] button, the display changes to the following figure.

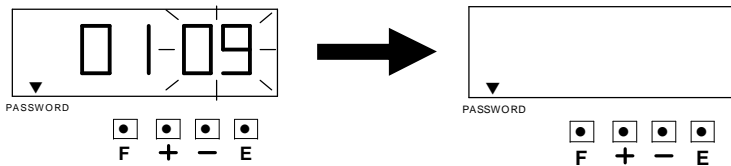

3. After you finished setting the password, press the [E] button again, the LCD screen will return to normal mode.

Deleting the Password

The code “----” must be entered to delete the password.

Example: Delete the password “0109”.

1. Press the [F] button and position the “▲” the “PASSWORD” mark.

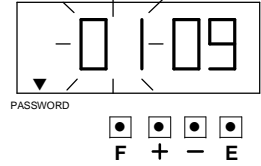

2. Press the [+] or [-] button to set the first two digits at [--], and then press [E] button. The display changes to the following figure.

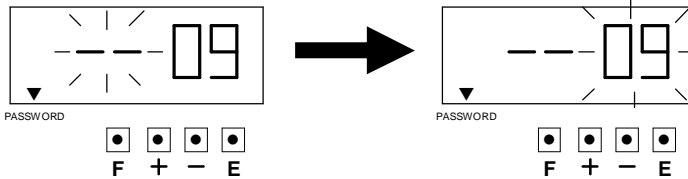

3. Press the [+] or [-] button to set the second two digits at [--], and then press [E] button. The display changes to the following figure.

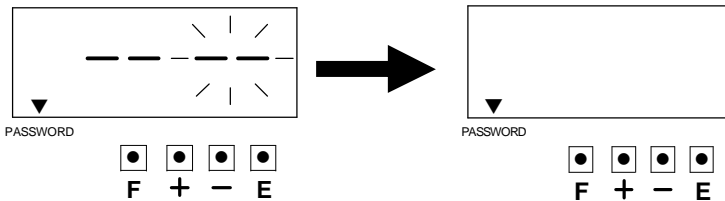

4. After you finished deleting the password, press the [E] button again, the LCD screen will return to normal mode.

21. RESET

When the reset switch is pushed, the program will return to the factory defaults. You must make a new setting.

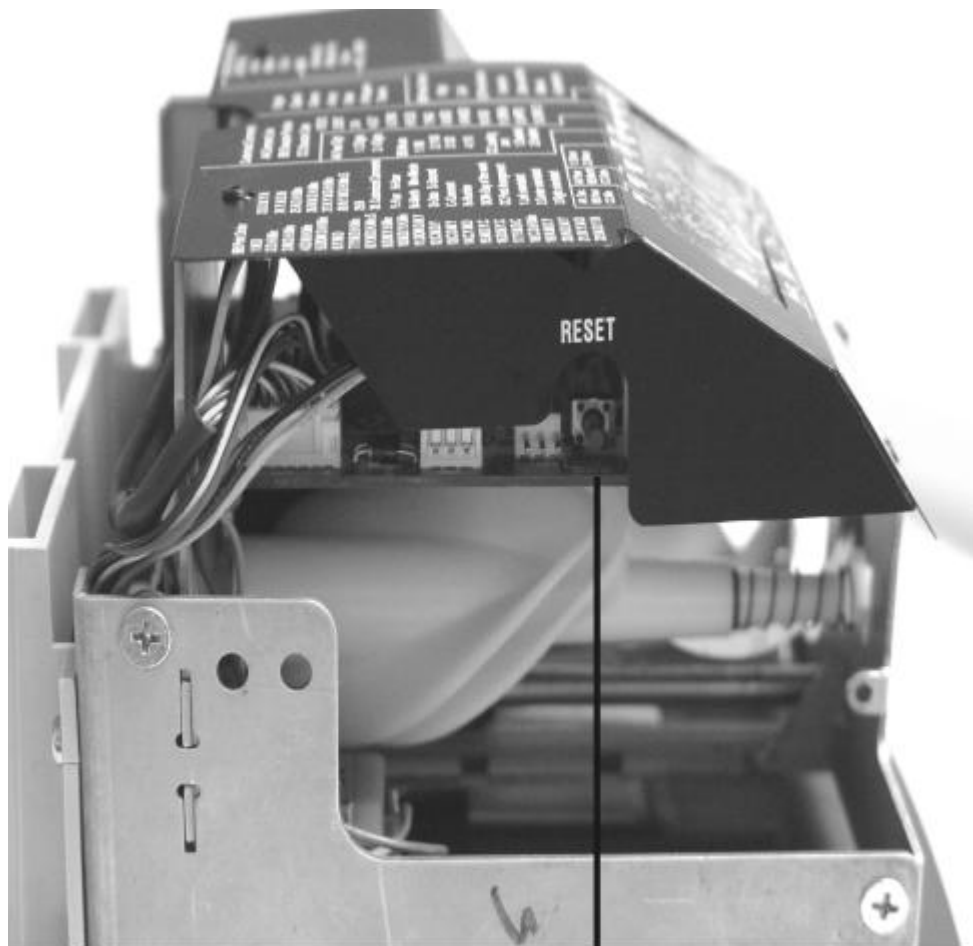

Reset Switch

22. WALL MOUNTING

Caution: The supplied screws are intended for use on a thick wooden wall or wooden column. Do not use any other materials. The Time Stamp may come off if used on other materials.

1. Install the supplied wall-mount screws into a wall by using the template.

Be sure to keep about 1/4" (6mm) of the screw head away from the wall.

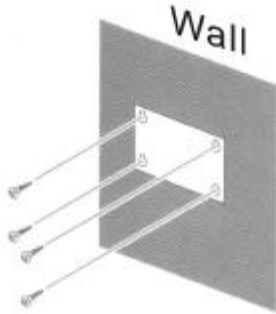

3. Replace cover and lock.



2. Unlock the key and remove the cover.
And then hang it on the wall.

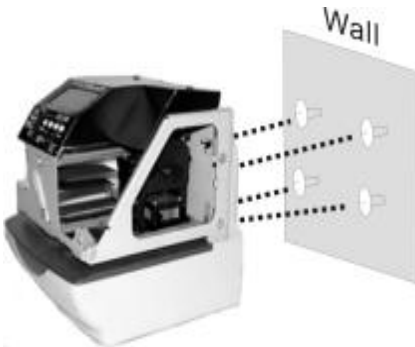

23. REPLACING THE RIBBON CARTRIDGE

1. Unlock the key and remove the cover.



2. Hold the ribbon cartridge by its tab and pull straight out to remove it.



3. Turn the knob of the new cartridge in direction of the arrow (clockwise) to tighten the ribbon.



4. Place the cartridge inside the Time Stamp as show in the following figure. Push the ribbon until it snaps into position. Turning the knob on the ribbon cartridge may make installation easier.



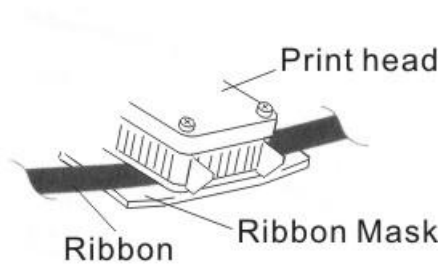

※**Notice:** install the ribbon cartridge so that the ribbon is between the print head and ribbon mask. Printing will not come out properly if the ribbon is placed behind the ribbon mask.

5. Turn the knob of the cartridge in the direction of the arrow to tighten the ribbon.

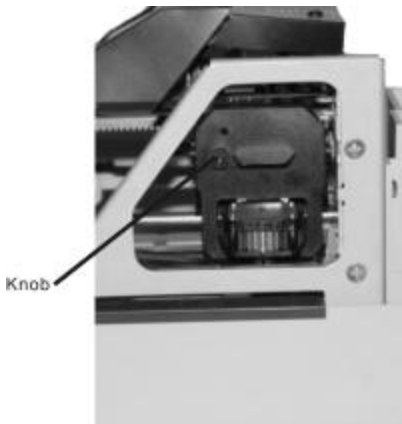

6. Replace the cover and lock.



24. CHARACTER CODE FOR ALPHANUMEC

Number: Sequential number HH: Hour MM: Minute SS: Second

DOW: Day of the week ※1 ~※15: Language Specific Character

Code	Character	Max. Dots
00	NULL	-
01	SPACE	3

Code	Meaning	Code	Meaning
F8	Insert Character	FC	Exchange Line 1 to 2
F9	Delete Character	FD	Exchange Line 2 to 3
FA	Insert Line	FE	Exchange Line 3 to 1
Fb	Delete Line	FF	Delete All

Large (BOLD) Character

Code	Character	Max. Dots	Code	Character	Max. Dots	Code	Character	Max. Dots
02	A	8	1b	Z	8	34	※4	-
03	B	8	1c	0	8	35	※5	-
04	C	8	1d	1	8	36	※6	-
05	D	8	1e	2	8	37	※7	-
06	E	8	1f	3	8	38	※8	-
07	F	8	20	4	8	39	※9	-
08	G	8	21	5	8	3a	※10	-
09	H	8	22	6	8	3b	※11	-
0a	I	5	23	7	8	3c	※12	-
0b	J	8	24	8	8	3d	※13	-
0c	K	8	25	9	8	3e	※14	-
0d	L	8	26	Year	32	3f	※15	-
0e	M	8	27	Month	24	40	'	3
0f	N	8	28	Date	16	41	*	7
10	O	8	29	Dow	16	42	+	7
11	P	8	2a	HH:MM	37(49)	43	,	5
12	Q	8	2b	HH:MM:SS	58(70)	44	-	7
13	R	8	2c	Number	8x(n)	45	.	5
14	S	8	2d	Number	8x(n)	46	/	8
15	T	7	2e	Number	8x(n)	47	:	5
16	U	8	2f	Number	8x(n)	48	:	5
17	V	8	30	Number	8x(n)	49	_	6
18	W	8	31	※1	-	4a	&	10
19	X	8	32	※2	-			
1a	Y	7	33	※3	-			

Note : () is to include the following meaning.

Code=26: 2/4 digit setting of Year, Code 2A and 2b: AM/PM setting of Hour,

Code=2C to 30: Number digits depend on the setting.

Large Character

Code	Character	Max. Dots	Code	Character	Max. Dots	Code	Character	Max. Dots
4b	A	7	64	Z	7	7d	※4	-
4c	B	7	65	0	7	7e	※5	-
4d	C	7	66	1	7	7f	※6	-
4e	D	7	67	2	7	80	※7	-
4f	E	7	68	3	7	81	※8	-
50	F	7	69	4	7	82	※9	-
51	G	7	6a	5	7	83	※10	-
52	H	7	6b	6	7	84	※11	-
53	I	4	6c	7	7	85	※12	-
54	J	7	6d	8	7	86	※13	-
55	K	7	6e	9	7	87	※14	-
56	L	7	6f	Year	28	88	※15	-
57	M	8	70	Month	22	89	'	3
58	N	7	71	Date	14	8a	*	6
59	O	7	72	Dow	15	8b	+	6
5a	P	7	73	HH:MM	32(44)	8c	,	4
5b	Q	7	74	HH:MM:SS	50(62)	8d	-	6
5c	R	7	75	Number	7x(n)	8e	-	4
5d	S	7	76	Number	7x(n)	8f	/	6
5e	T	6	77	Number	7x(n)	90	:	4
5f	U	7	78	Number	7x(n)	91	:	4
60	V	7	79	Number	7x(n)	92	_	5
61	W	8	7a	※1	-	93	&	9
62	X	7	7b	※2	-			
63	Y	6	7c	※3	-			

Note : () is to include the following meaning.

Code=6F: 2/4 digit setting of Year, Code =73 and 74: AM/PM setting of Hour,

Code=75 to 79: Number digits depend on the setting.

Small Character

Code	Character	Max. Dots	Code	Character	Max. Dots	Code	Character	Max. Dots
94	A	6	b5	7	6	d6	HH:MM	26(37)
95	B	6	b6	8	6	d7	HH:MM:SS	40(57)
96	C	6	b7	9	5	d8	Number	6x(n)
97	D	6	b8	a	5	d9	Number	6x(n)
98	E	6	b9	b	5	da	Number	6x(n)
99	F	6	ba	c	5	db	Number	6x(n)
9a	G	6	bb	d	5	dc	Number	6x(n)
9b	H	6	bc	e	5	dd	※1	—
9c	I	4	bd	f	4	de	※2	—
9d	J	6	be	g	5	df	※3	—
9e	K	6	bf	h	5	ea	※4	—
9f	L	6	ca	i	2	eb	※5	—
a0	M	6	cb	j	3	ec	※6	—
a1	N	6	cc	k	5	ed	※7	—
a2	O	6	cd	l	2	ee	※8	—
a3	P	6	ce	m	6	ef	※9	—
a4	Q	6	cf	n	5	eg	※10	—
a5	R	6	ca	o	5	eh	※11	—
a6	S	6	cb	p	5	ei	※12	—
a7	T	6	cc	q	5	ej	※13	—
a8	U	6	cd	r	5	ek	※14	—
a9	V	6	ce	s	5	el	※15	—
aa	W	6	cb	t	4	em	'	3
ab	X	6	cc	u	5	en	+	6
ac	Y	6	cd	v	5	eo	+	6
ad	Z	6	ce	w	6	ep	,	4
ae	0	6	cf	x	6	eq	-	5
af	1	6	da	y	5	er	.	4
b0	2	6	db	z	6	es	/	6
b1	3	6	dc	Year	24	et	:	4
b2	4	6	dd	Month	18	eu	:	4
b3	5	6	de	Date	12	ev	_	4
b4	6	6	de	DOW	12	ew	&	8

Note : () is to include the following meaning.

Code=d2: 2/4 digit setting of Year, Code =d6 and d7: AM/PM setting of Hour,

Code=d8 to dC: Number digits depend on the setting.

Language-Specific Character

English

	※1	※2	※3	※4	※5	※6	※7	※8	※9	※10	※11	※12	※13	※14	※15
Character	#	\$	@	[\]	^	`	()	~	EURO		
Dots	Bold	9	9	9	7	8	7	8	5	7	5	7	7	8	
	Large	7	6	7	6	6	6	6	4	6	4	6	6	7	
	Small	6	6	6	5	6	5	4	3	5	4	5	6	6	

Spanish

	※1	※2	※3	※4	※5	※6	※7	※8	※9	※10	※11	※12	※13	※14	※15
Character	Pt	\$	@	ı	Ñ	¿	´	`	¨	ñ	}	~	EURO		
Dots	Bold	11	9	9	5	8	7	5	5	9	7	7	7	8	
	Large	8	6	7	4	7	6	4	4	7	7	6	6	7	
	Small	8	6	6	4	6	6	3	3	7	6	5	6	6	

German

	※1	※2	※3	※4	※5	※6	※7	※8	※9	※10	※11	※12	※13	※14	※15
Character	#	\$	§	Ä	Ö	Ü	^	`	ä	ö	ü	ß	EURO		
Dots	Bold	9	9	8	8	8	8	5	7	7	7	8	8		
	Large	7	6	7	7	7	7	6	4	7	6	6	7	7	
	Small	6	6	6	6	6	6	4	3	5	5	5	6	6	

French

	※1	※2	※3	※4	※5	※6	※7	※8	※9	※10	※11	※12	※13	※14	※15
Character	#	\$	à	°	ç	§	^	`	é	ù	è	¨	EURO		é
Dots	Bold	9	9	7	4	7	8	8	5	7	7	7	9	8	8
	Large	7	6	7	4	6	7	6	4	6	6	6	7	7	7
	Small	6	6	5	4	5	6	4	3	5	5	5	7	6	6

Italian

	※1	※2	※3	※4	※5	※6	※7	※8	※9	※10	※11	※12	※13	※14	※15
Character	#	\$	@	°	\	é	^	ù	à	ò	è	ı	EURO		
Dots	Bold	9	9	9	4	8	7	8	7	7	7	5	8		
	Large	7	6	7	4	6	6	6	6	7	6	6	4	7	
	Small	6	6	6	4	6	5	4	5	5	5	5	4	6	

Portuguese

	※1	※2	※3	※4	※5	※6	※7	※8	※9	※10	※11	※12	※13	※14	※15
Character	#	\$	@	[\]	^	`	{		}	~	EURO		
Dots	Bold	9	9	9	7	8	7	8	5	7	5	7	7	8	
	Large	7	6	7	6	6	6	6	4	6	4	6	6	7	
	Small	6	6	6	5	6	5	4	3	5	4	5	6	6	

Numeric

	※1	※2	※3	※4	※5	※6	※7	※8	※9	※10	※11	※12	※13	※14	※15
Character	#	\$	@	[\]	^	`	{		}	~	EURO		
Dots	Bold	9	9	9	7	8	7	8	5	7	5	7	7	8	
	Large	7	6	7	6	6	6	6	4	6	4	6	6	7	
	Small	6	6	6	5	6	5	4	3	5	4	5	6	6	

25. INSTALLING THE Ni-Cd BATTERY (OPTIONAL)

※ Optional back-up battery will require approximately 72 hours to fully recharge.

1. Unlock the key and remove the cover.



3. Replace the cover and lock.



2. Insert the battery connector into the compartment connector (CN7) to install the battery.

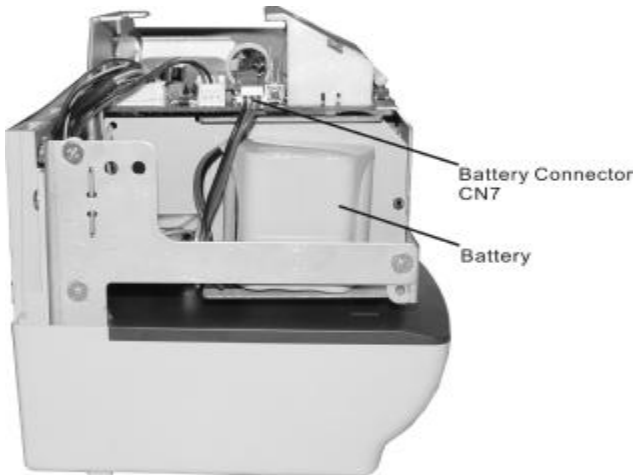

26. CONNECTING THE EXTERNAL TIME SIGNAL (OPTIONAL)

1. Unlock the key and remove the cover.



3. The two wires of external alarm unit, inset into the external time signal connector of time stamp.

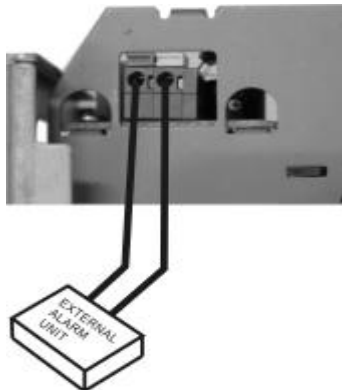

2. The connector for external time signal is on the back of the time stamp.

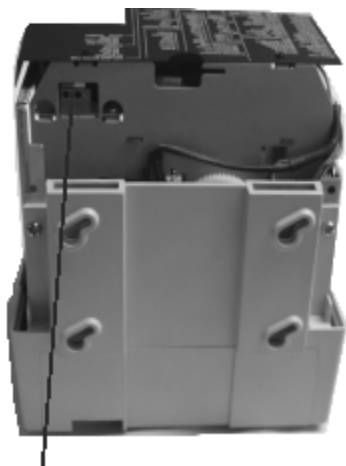

External Time Signal
Connector

4. Replace the cover and lock.



27. TROUBLESHOOTING

1. The Time Stamp does not operate.

Ensure the power cord is properly plugged into the AC outlet.

2. The Time Stamp does not print.

Ensure the ribbon cartridge is installed correctly.

3. The card is jammed.

Press the push bar and try to pull out the card at the same time.

4. List of the error code:

a. E-38: can not print.

The printer head motor or the sensor does not operate properly.

Ensure the ribbon cartridge is installed correctly.

b. E-40: Incorrect password.

Enter the correct password again.

c. E-49: setting data is not usable.

Refer to your user's manual on the page related to the item you want to set and enter correct setting data.