



Model 1600E

User's Guide



Tru-Align™ 

AtomicTime™ 

www.lathem.com

WARNING

This equipment has been tested and found to comply with the limits for a Class A digital device, pursuant to Part 15 of FCC Rules. These limits are designed to provide reasonable protection against harmful interference when the equipment is operated in a commercial environment. This equipment generates, uses, and can radiate radio frequency energy and, if not installed and used in accordance with the instruction manual, may cause harmful interference to radio communications. Operation of this equipment in a residential area is likely to cause harmful interference in which case the user will be required to correct the interference at his or her own expense.

Caution: Changes or modifications not expressly approved by the party responsible for compliance could void the user's authority to operate the equipment.

This digital apparatus does not exceed the class a limits for radio noise emissions from digital apparatus as set out in the radio interference regulations of the canadian department of communications.

Le présent appareil numérique n'émet pas de bruits radioélectriques dépassant les limites applicables aux appareils numériques de classe a prescrites dans le règlement sur le brouillage radioélectrique édicté par le ministère des communications du canada.



Lathem Time Corporation

www.lathem.com

(800) 241-4990

This User's Manual and its contents are copyrighted by LATHEM TIME CORP. with all rights reserved.

INTRODUCTION

The Model 1600E

Using the same technology NASA employs to tell time, the Model 1600E wirelessly synchronizes with the National Institute of Standards and Technology's atomic clock in Boulder, Colorado. In addition to confirming the time daily, the 1600E automatically adjusts for Daylight Saving Time. No wires, no worries, and no more excuses for being late.

About Your Atomic Clock

In addition to a regular quartz time clock, the Model 1600E contains an antenna and a microchip. The antenna receives the official time signal from the US Government's National Institute of Standards and Technology and the microchip translates the time signal and adjusts the time display to the correct time. The Model 1600E receives a 60-kilohertz, low frequency AM radio signal from the WWVB radio station maintained by the National Institute of Standards and Technology (NIST). The NIST, using its atomic clock, is the official timekeeper for the US and is located in Boulder, Colorado. The Model 1600E will work anywhere it can receive the WWVB signal from the NIST. This signal is broadcast to reach across the continental US and into parts of Canada and Mexico. To learn more about the NIST time correction technology used in the Model 1600E, you can visit: <http://www.nist.gov/pml/div688/>

Features

Main applications: Payroll/job cost recorder or time stamp

- Tru-Align™ Printing
 - Internal Light
 - Quartz time clock
 - Atomic clock function
 - Dot matrix printer
 - Perpetual calendar
 - Automatic daylight saving time
 - 4-way print activation
 - Automatic
 - Semi-automatic
 - Manual
 - Tru-Align
- Prints in 4 languages
 - 12 or 24-hour format
 - Regular minute, 1/10, 1/100 or 5/100 of an hour
 - 2 or 4-digit year imprint
 - 13 preprogrammed comments
 - Digital LCD display (Date, Hour, Minute, Day of the week indication)
 - Adjustable print position
 - Prints seconds

CAUTION

Avoid placing the unit in environments that are:

- humid or dusty.
- exposed to direct sunshine.
- subject to frequent or continuous vibrations.
- outside the temperature range between -5°C and 45°C (+23°F and 113°F).
- affected by chemicals or ozone.

Place the time clock close to the wall outlet so that it is easily accessible to disconnect.

Do not put a heavy object on the clock, or not forcefully press the cover of the clock. It may cause mechanism trouble and danger especially when the unit is hung on the wall.

Lithium battery contains perchlorate material - special handling may apply.

Please go to web site <http://www.dtsc.ca.gov/hazardouswaste/perchlorate> for information about proper methods of disposal.

**Only use the AC adapter supplied with the unit.
Using a different AC adapter may cause
electrical shock or fire, or damage the unit.
Do not use the AC adapter with any other unit.**

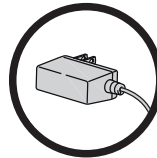

#Q7169-52100
ONLY

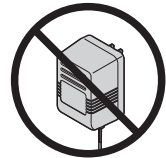

DO NOT USE

ACCESSORIES

- VIS6011 - Ribbon Cartridge (Black)
- VIS6008 - Ribbon Cartridge (Purple)
- VIS6007 - Ribbon Cartridge (Red)
- E16 - Weekly TruAlign Time Cards
- 25-9EX - Time Card Rack, 9" Cards, 25 Pockets, Expanding
- Q7169-52100 - Replacement AC Adapter

For questions about the operation of this time clock, or to order supplies and accessories, please contact Lathem Time at (800)241-4990 or visit www.lathem.com.

PACKAGE CONTENTS

CONTENTS

In addition to the 1600E and AC adapter:

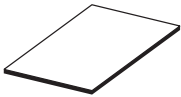

User's manual



Key



Wall-mount fittings
Screws (2 pcs.)

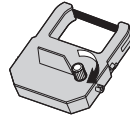

Ribbon cassette
(installed at
the factory)

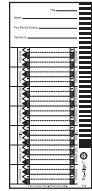

Sample pack of
Weekly TruAlign
Time Cards

OVERVIEW

(Front view)

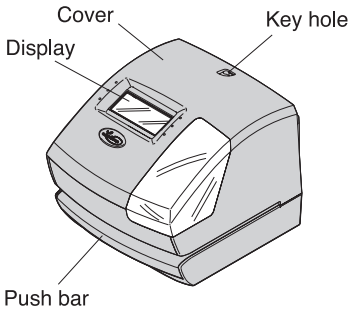

(Cover off)

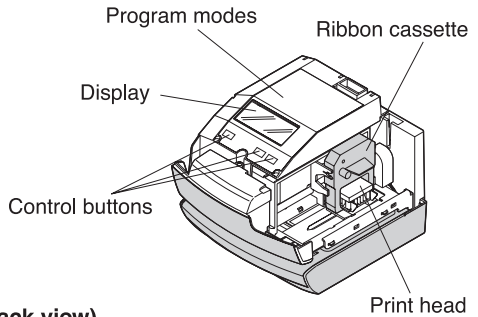

(Back view)

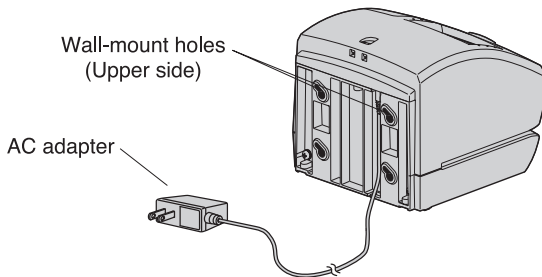

QUICK EASY SETUP

NOTICE: Remove the **PROTECTION PAD** before you plug the AC adapter into the AC outlet.

To setup your time clock, follow next steps:

Step 1

Unlock the key and remove the cover.

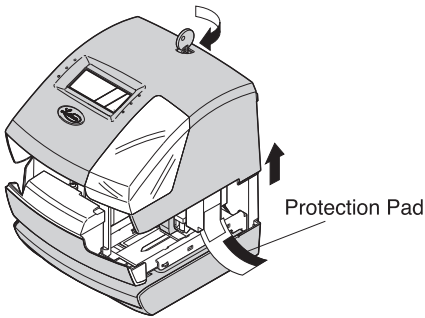

Step 2

Remove the **PROTECTION PAD**, and plug the AC adapter into the time clock.

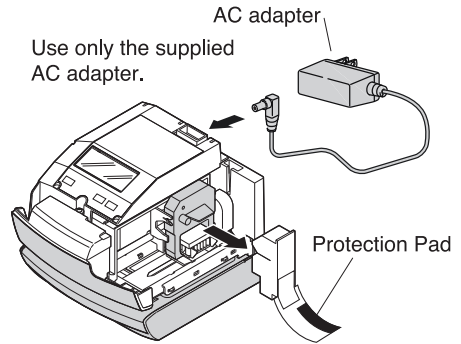

Step 3

Plug the AC adapter into the AC outlet and program the clock.

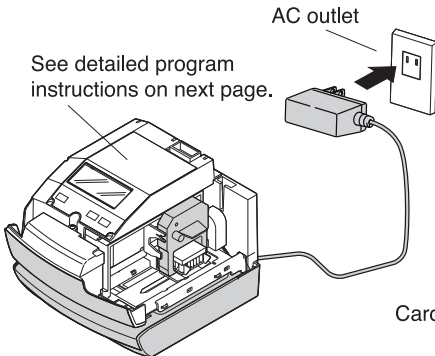

Step 4

Replace the cover, lock and insert a time card.

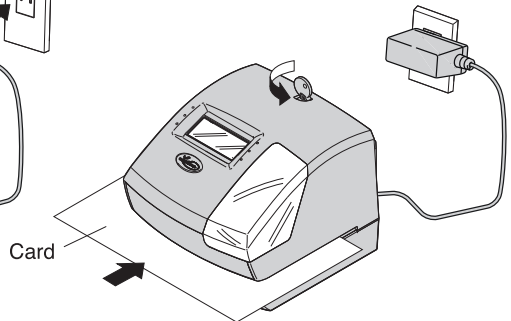

WALL MOUNTING

Caution: The supplied screws are intended for use on a thick wooden wall or wooden column. Do not use them on any other materials. The time clock may come off if used on other materials.

Just as with an AM radio, the Model 1600E can be positioned for optimal reception. For instance, it is best to position the clock away from metal studs and toward the direction of the tower in Colorado.

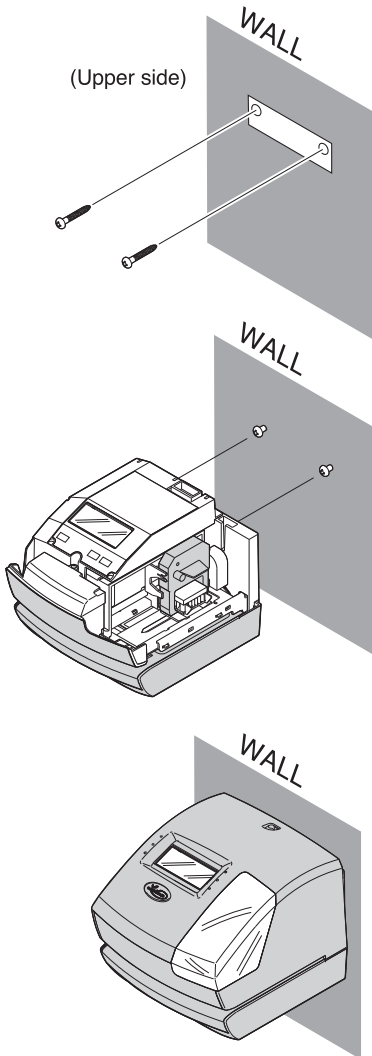

Step 1

Install the supplied wall-mount screws into a wall by using the template **located on the inside back cover**.

Be sure to keep about 6 mm of the screw head away from the wall.

Step 2

Unlock the key and remove the cover. And then hang it on the wall.

Step 3

Replace the cover and lock.

HOW TO PROGRAM THE CLOCK

To enter the program setting mode, you should plug the AC adapter into the AC outlet and remove the cover. Thereafter press the **SELECT** button once. Then the clock goes into the program mode showing the "▲" on the display positioned at the "TIME".

L.C.D.
Reference for programming

PRINT ORDER

Y=Year	1.M,D,H,Min	10.M,D
M=Month	2.D,M,H,Min	11.DOW,D,M,Y
D=Date	3.M,D,Y,H,Min	12.C,M,D,Y
DOW=Day of the week	4.D,M,Y,H,Min	13.C,D,M,Y
H=Hour	5.Y,M,D,H,Min	14.C,Y,M,D
Min=Minute	6.Y,M,D,H,Min,S	15.M,D,Y,C
S=Second	7.D,H,Min	16.D,M,Y,C
C=Comment	8.DOW,D,H,Min	17.Y,M,D,C
	9.Y,M,D	18.C,D,H,Min
		19.DOW,M,D,Y,H,Min

DISPLAY

AA:Sec.	AA:Year	1.12hour
BB:Hour	BB:Month	2.24hour
CC:Min.	CC:Date	

PRINT STYLE

1.2Digits	BB:Hour	1.ZERO	1.RCVD
2.4Digits	1.12hour	Disabled	2.SENT
	2.24hour	2.ZERO	3.IN
		Enabled	4.OUT
CC:Minute			5.CFMD
1.1/60			6.FILED
2.1/100			7.PAID
3.1/20			8.USED
4.1/10			9.FAXED
			10.VOID
			11.ORIGN
			12.APR'D
			13.CMPL'D

LANGUAGE

- ENGLISH
- FRENCH
- SPANISH
- PORTUGUESE

CONTROL buttons

- SELECT**: Password (1. Eastern, 2. Central, 3. Mountain, 4. Pacific, 5. Other, 6. No reception)
- CHANGE**: Daylight Saving Time (AA:Year, BB:Month, CC:Date)
- SET**: Print Direction (1. Right, 2. Left), Print Activation (1. Automatic, 2. Semi-automatic, 3. Manual, 4. Tru-Align)

NEW! PRINT METHOD: *Adjust Print Position on bottom of clock to "back"

Function of 3 control buttons

SELECT: You can select the desired program setting mode by pressing this **SELECT** button. Selected program setting mode is indicated by the "▲" mark on the display.

CHANGE: When you press the **CHANGE** button, you can increment the set value.

SET: You can set the value selected on the display by pressing the **SET** button. Thereafter you press this **SET** button again, you can return the clock to the normal operation mode.

FACTORY SETTINGS

IMPORTANT

This unit has been preset to the Eastern Time Zone. **If this unit will be used in any other time zone YOU MUST CHANGE THE TIME ZONE before use.** (See page 25 for detailed instructions).*

This unit has been preset to perform automatic Daylight Saving Time (DST) changes. **If your location does not observe DST changes YOU MUST DISABLE DST CORRECTION before use.** (See page 24 for detailed instructions).*

Item	Default Settings	Options	Page
Time	Current Eastern Time	Change Time	10
Date	Current Date	Change Date	11
Display Hours Format	12 Hour (AM/PM)	24 Hour	12
Print Order	Month, Date, Hours, Minutes	19 Formats Available	13
Print Year Digits	2 (YY)	4 Digit (YYYY)	14
Print Hours	12 Hour	24 Hour	15
Print Minutes	0-60	1/10, 1/100, 1/20 of an hour	15
Print Leading Zero	Disabled	Enabled	16
Print Comment	RCVD (if set in Print Order)	13 Comments Available	17
Print Language	English	French, Spanish, Portuguese	18
Print Direction	Right	Left	19
Print Activation	Automatic	Semi-Automatic, Manual, Tru-Align	19
*Daylight Saving Time Start	2nd Sunday in March	Change Start, Disable	21
*Daylight Saving Time End	1st Sunday in November	Change End, Disable	23
*Time Zone for Atomic Clock	Eastern	Central, Mountain, Pacific, Adjust Minutes Only, Disable	25
Password	Disabled (0000)	Enable	27

USING TRU-ALIGN

About Tru-Align

The 1600E's unique Tru-Align option ensures that employee punches are perfectly aligned on the time card. A sensor on the unit reads special markings on Tru-Align time cards and prints automatically when the card is properly aligned. This eliminates misaligned punches and overprinting of lines, and provides a clean and easy to read time card.

Tru-Align Time Cards

Tru-Align requires the use of Lathem's special Tru-Align Time Cards. These cards contain special markings that allow the 1600E to print automatically when the card is aligned, and Tru-Align is enabled. See instructions below to enable Tru-Align. A pack of E16 Weekly Tru-Align Time Cards are included. You can purchase additional Tru-Align Time Cards online at <http://shop.lathem.com>.

Enabling Tru-Align

By default, Tru-Align is Off.

To enable Tru-align, follow two easy steps:

1. **Set Print Position Adjuster** – the print position adjuster on the bottom of the units must be set to the back position indicated by the label. (See next page).
2. **Set Print Activation** – change the Print Activation to option (4) Tru-Align. (See page 19).

Tru-Align Indicator

When Tru-Align is enabled, the Tru-Align indicator will display on the bottom right corner of the unit's LCD display.



Using Tru-Align

Insert Tru-Align time cards into 1600E with leading edge containing alignment marks. The 1600E will print automatically when the card is aligned in the print cell. If the card is misaligned, adjust the card position slightly until printing occurs.

Alignment Marks

Tru-Align
Time Card

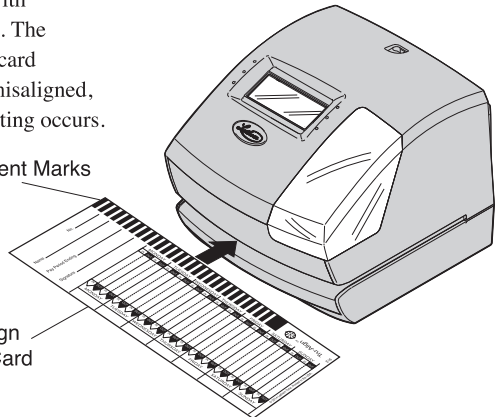

ADJUST PRINT POSITION

SET PRINT POSITION ON TIME CARD

The print position from the card edge is adjustable by pressing and sliding the print position button located on the right outside bottom of the recorder. Maximum distance from edge of form to print is approximately 1 3/16" (30mm) necessary for Tru-Align time cards.

Located on the bottom of the 1600E.

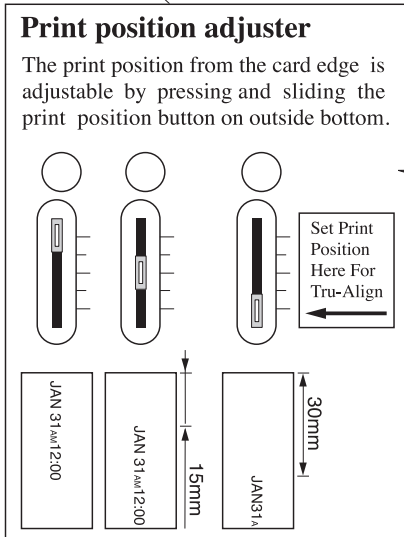

IMPORTANT: If **Tru-Align** is enabled you must set the print position adjuster as shown.

SETTING THE DISPLAY FORMAT

SETTING THE TIME

It is recommended that during initial installation you manually set the time, date, and time zone. (See "SETTING THE TIME ZONE" section.) The 1600E will automatically correct itself when it receives a radio signal from the atomic clock.

Example: Change the time from 10:08 to 10:09.

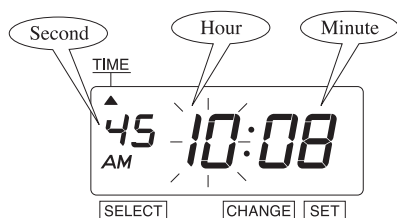

Step 1

Press the **SELECT** button and position the "▲" mark at the "TIME".

At that moment, the "Hour" flashes. (The flashing means it can be changed.)

Change the "Hour".

In case of the example, press the **SET** button because the hour is not to be changed.

At that moment, the flashing changes from "Hour" to "Minute".

Step 2

Change the "Minute".

Press the **CHANGE** button to set at "09", and then press the **SET** button.

At that moment, the "Second" starts to run from "00".

Step 3

After you finish setting the time, press the **SET** button once again.

Now the time setting has been completed. Replace the cover and lock.

IMPORTANT: If you do not complete Step 3, the clock will not print.

SETTING THE DATE

Example: Change the date from October 20, 2014 to October 21, 2014.

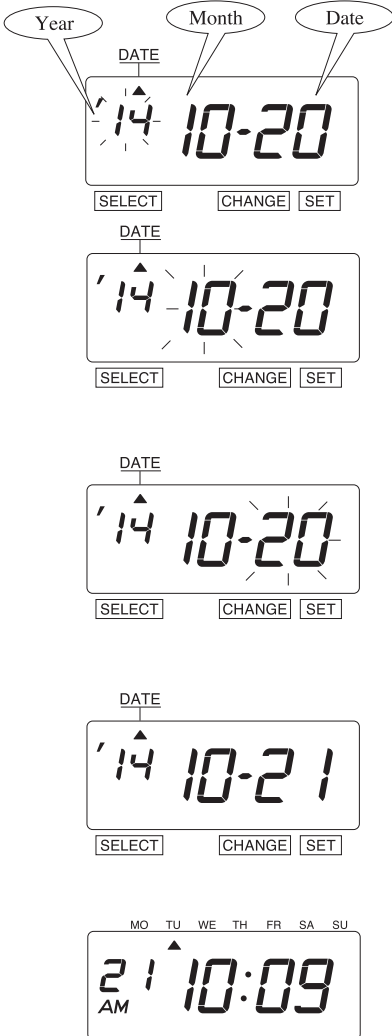

Step 1

Press the **SELECT** button and position the "▲" mark at the "DATE".

At that moment, the "Year" flashes. (The flashing means it can be changed.)

Change the "Year".

In case of the example, press the **SET** button because the year 2014 is not to be changed.

At that moment, the flashing changes from "Year" to "Month".

Step 2

Change the "Month".

In case of the example, press the **SET** button because the month is not to be changed.

At that moment, the flashing changes from "Month" to "Date".

Step 3

Change the "Date".

Press the **CHANGE** button to set at "21", and then press the **SET** button.

Step 4

After you finish setting the date, press the **SET** button once again.

Now the date setting has been completed. Replace the cover and lock.

IMPORTANT: If you do not complete Step 4, the clock will not print.

SETTING THE 12/24 HOUR

Example: Change the hour format to 24 hour.

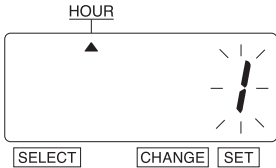

Step 1

Press the **SELECT** button and position the "▲" mark at the "HOUR". At that moment, the flashing digit indicates "Order Options" of the hour format. (The flashing means it can be changed.)

	Order Options	Display
1.	12 hour	PM 3:00
2.	24 hour	15:00

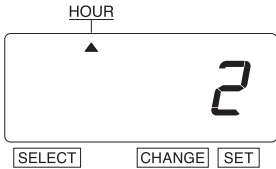

In case of the example, press the **CHANGE** button to set at "2". And then press the **SET** button.



Step 2

After you finish setting the 12/ 24 hour, press the **SET** button once again. Now the 12/24 hour setting has been completed. Replace the cover and lock.

IMPORTANT: If you do not complete Step 2, the clock will not print.

SETTING THE PRINT ORDER

Example: Change the print order to "Month, Date, Year, Hour, Minute".

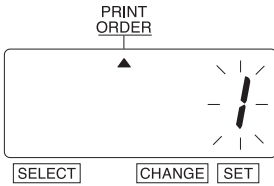

Step 1

Press the **SELECT** button and position the "▲" mark at the "PRINT ORDER".

At that moment, the flashing digits indicate "Order Options" of the print order. (The flashing means it can be changed.)

Y=Year, M=Month, D=Date, DOW=Day of the week, H=Hour, Min=Minute
S=Second, C=Comment

	Order Option	Print Example
1.	M, D, H, Min	JAN 31 AM10:00
2.	D, M, H, Min	31 JAN AM10:00
3.	M, D, Y, H, Min	JAN 31 '15 AM10:00
4.	D, M, Y, H, Min	31 JAN '15 AM10:00
5.	Y, M, D, H, Min	'15 JAN 31 AM10:00
6.	Y, M, D, H, Min, S	'15 JAN 31 AM 10:00:00
7.	D, H, Min	31 AM10:00
8.	DOW, D, H, Min	SA, 31 AM10:00
9.	Y, M, D	'15 JAN 31
10.	M, D	JAN 31
11.	DOW, D, M, Y	SA, 31 JAN '15
12.	C, M, D, Y	SENT JAN 31 '15
13.	C, D, M, Y	SENT 31 JAN '15
14.	C, Y, M, D	SENT '15 JAN 31
15.	M, D, Y, C	JAN 31 '15 SENT
16.	D, M, Y, C	31 JAN '15 SENT
17.	Y, M, D, C	'15 JAN 31 SENT
18.	C, D, H, Min	SENT 31 AM10:00
19.	DOW, M, D, Y, H, Min	SA, JAN 31 '15 AM10:00

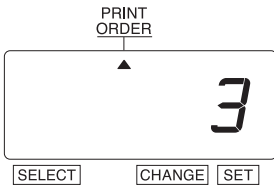

In case of the example, press the **CHANGE** button to set at "3". And then press the **SET** button.

Step 2

After you finish setting the print order, press the **SET** button once again.

Now the print order setting has been completed. Replace the cover and lock.



IMPORTANT: If you do not complete Step 2, the clock will not print.

SETTING THE PRINT STYLE

SETTING THE YEAR DIGIT

Example: Change the year imprint to 4 digits.

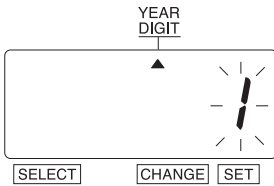

Step 1

Press the **SELECT** button and position the "▲" mark at the "YEAR DIGIT".

At that moment, the flashing digit indicates "Order Options" of the year imprint. (The flashing means it can be changed.)

	Order Options	Print Example
1.	2 Digits	JAN 31 '15 AM10:00
2.	4 Digits	JAN 31 2015 AM10:00

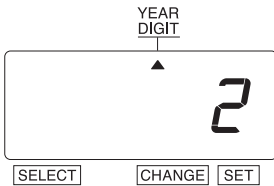

In case of the example, press the **CHANGE** button to set at "2", and then press the **SET** button.

Step 2

After you finish setting the year digit, press the **SET** button once again.

Now the year digit setting has been completed. Replace the cover and lock.



IMPORTANT: If you do not complete Step 2, the clock will not print.

SETTING THE HOUR/MIN.

Example: Change the print style of the "Hour" and "Minute" to 24 hour and 1/100 min.

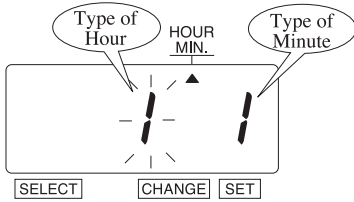

Step 1

Press the **SELECT** button and position the "▲" mark at the "HOUR /MIN".
At that moment, the flashing digit at the left indicates "Order Options" of the print style of the "Hour". (The flashing means it can be changed.)

Change the "Hour".

	Order Options	Print Example
1.	12 Hour	JAN 31 PM3:00
2.	24 Hour	JAN 31 15:00

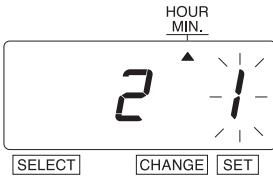

In case of the example, press the **CHANGE** button to set at "2". And then press the **SET** button.
At that moment, the flashing changes from "Hour" to "Minute".

Step 2

Change the "Minute".

	Order Options	Print Example		Order Options	Print Example
1.	1/60 Min.	JAN 31 AM12:10	3.	1/20 Min. (=5/100 Min.)	JAN 31 AM12.15
2.	1/100 Min.	JAN 31 AM12.17	4.	1/10 Min.	JAN 31 AM12.1

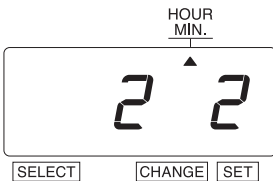

In case of the example, press the **CHANGE** button to set at "2". And then press the **SET** button.

Step 3

After you finish setting the hour/minute, press the **SET** button once again.
Now the hour/minute setting has been completed. Replace the cover and lock.



IMPORTANT: If you do not complete Step 3, the clock will not print.

SETTING THE LEADING ZERO

Example: Change the leading zero to "ZERO: Disabled".

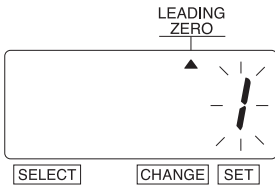

Step 1

Press the **SELECT** button and position the "▲" mark at the "LEADING ZERO". At that moment, the flashing digit indicates "Order Options" of the leading zero.

(The flashing means it can be changed.)

	Order Options	Print Example
1.	ZERO Disabled	JAN 1 PM3:00
2.	ZERO Enabled	JAN 01 PM03:00

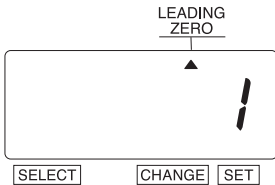

In case of the example, press the **CHANGE** button to set at "1". And then press the **SET** button.

Step 2

After you finish setting the leading zero, press the **SET** button once again.

Now the leading zero setting has been completed. Replace the cover and lock.

IMPORTANT: If you do not complete Step 2, the clock will not print.



SETTING THE COMMENT

Example: Change the comment to "SENT".

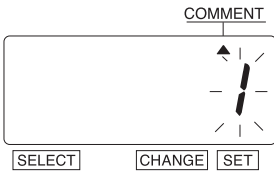

Step 1

Press the **SELECT** button and position the "▲" mark at the "COMMENT".
 At that moment, the flashing digits indicate "Order Options" of the comment.
 (The flashing means it can be changed.)

	Order Options	Print Example
1.	RCVD	JAN 31 '15 RCVD
2.	SENT	JAN 31 '15 SENT
3.	IN	JAN 31 '15 IN
4.	OUT	JAN 31 '15 OUT
5.	CFMD	JAN 31 '15 CFMD
6.	FILED	JAN 31 '15 FILED
7.	PAID	JAN 31 '15 PAID
8.	USED	JAN 31 '15 USED
9.	FAXED	JAN 31 '15 FAXED
10.	VOID	JAN 31 '15 VOID
11.	ORIGN	JAN 31 '15 ORIGN
12.	APR'D	JAN 31 '15 APR'D
13.	CMPL'D	JAN 31 '15 CMPL'D

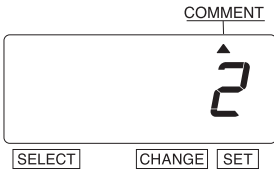

In case of the example, press the **CHANGE** button to set at "2". And then press the **SET** button.



Step 2

After you finish setting the comment, press the **SET** button once again.
 Now the comment setting has been completed. Replace the cover and lock.

IMPORTANT: If you do not complete Step 2, the clock will not print.

SETTING THE LANGUAGE

This setting is available if you select "Month," "Day of the week" or "Comment" in previous "PRINT ORDER".

Example: Change the print language into French.

Step 1

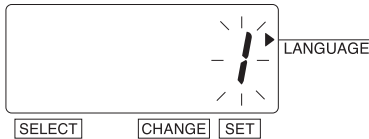

Press the **SELECT** button and position the "▲" mark at the "LANGUAGE". At that moment, the flashing digit indicates "Order Options" of the print language. (The flashing means it can be

	Order Options	Print Example
1.	ENGLISH	WE, 24 DEC '14 OUT 31 AM10:00
2.	FRENCH	ME, 24 DEC '14 SORT 31 AM10:00
3.	SPANISH	MI, 24 DIC '14 SAL 31 AM10:00
4.	PORTUGUESE	QA, 24 DEZ '14 SAIDA 31 AM10:00



In case of the example, press the **CHANGE** button to set at "2". And then press the **SET** button.



Step 2

After you finish setting the language, press the **SET** button once again. Now the language setting has been completed. Replace the cover and lock.

IMPORTANT: If you do not complete Step 2, the clock will not print.

SETTING THE PRINT METHOD

Example: Change the print direction to "Left" and the print activation to "Manual".

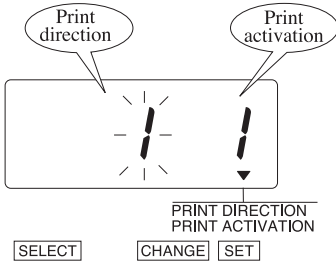

Step 1

Press the **SELECT** button and position the "▲" mark at the "PRINT DIRECTION; PRINT ACTIVATION".

At that moment, the flashing digit at the left indicates "Order Options" of the print direction. (The flashing means it can be changed.)

Change the "Print Direction".

	Order Options
1.	Right
2.	Left

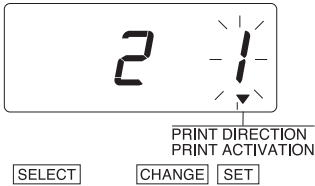

In case of the example, press the **CHANGE** button to set at "2". And then press the **SET** button.

At that moment, the flashing changes from the "Print Direction" to the "Print Activation".

Step 2

Change the "Print Activation".

	Order Options
1.	Automatic
2.	Semi-automatic
3.	Manual
4.	Tru-Align

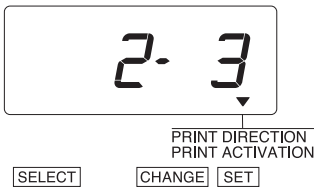

In case of the example, press the **CHANGE** button to set at "3". And then press the **SET** button.

Step 3



After you finish setting the print method, press the **SET** button once again. Now the print method setting has been completed. Replace the cover and lock.

IMPORTANT: If you do not complete Step 3, the clock will not print.

Automatic will allow the clock to print by simply inserting a card or sheet of paper.

Semi-automatic will allow the clock to print by pressing the push bar only when a card or piece of paper is inserted.

Manual will allow the clock to print by pressing the push bar.

Tru-Align will allow the clock to print automatically only when Tru-Align cards are properly aligned.

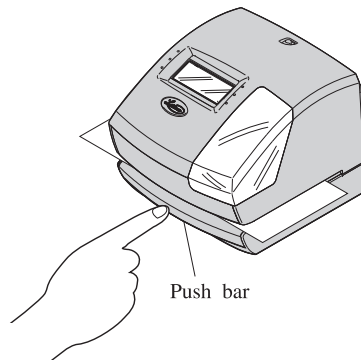

SETTING THE DAYLIGHT SAVING TIME

Automatic DST correction (recommended)

By default, the daylight saving time is already set to start on the second Sunday of March and to end on the first Sunday of November. However, if you once disabled this function and want to set it again or change starting and/or ending date, please change dates as follows.

Once you reset the unit, setting of daylight saving time will return to the default value.

Example: Start date Sunday, March 8, 2015.

End date Sunday, November 1, 2015.

If you set as the above, **the time clock remembers the start date as the second Sunday of March and the end date as the first Sunday of November.** Once set, the time clock automatically updates the settings every year thereafter. No further manual setting is necessary.

SETTING THE STARTING DATE OF DAYLIGHT SAVING TIME

Example: Daylight saving time starts on Sunday, March 8, 2015.

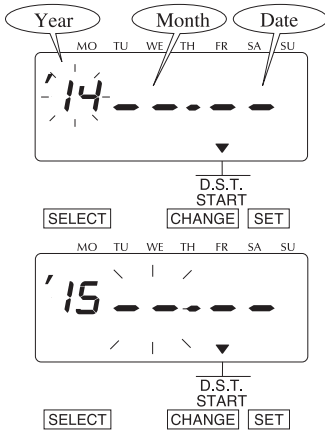

Step 1

Press the **SELECT** button and position the "▲" mark at the "D.S.T. START".

At that moment, the "Year" flashes.

(The flashing means it can be changed.)

Change the "Year".

In case of the example, press the **CHANGE** button to set at "15". And then press the **SET** button.

At that moment, the flashing changes from "Year" to "Month".

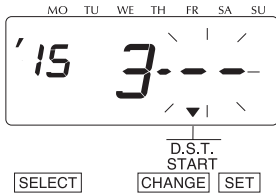

Step 2

Change the "Month".

Press the **CHANGE** button to set at "3".
And then press the **SET** button.
At that moment, the flashing changes from "Month" to "Date".

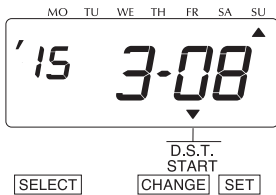

Step 3

Change the "Date".

Press the **CHANGE** button to set at "08".
And then press the **SET** button.



Step 4

After you finish setting the starting date of D.S.T., press the **SET** button once again.
Now the starting date of D.S.T. setting has been completed.

Go on to the "SETTING THE ENDING DATE OF DAYLIGHT SAVING TIME".

SETTING THE ENDING DATE OF DAYLIGHT SAVING TIME

Example: Daylight saving time ends on Sunday, November 1, 2015.

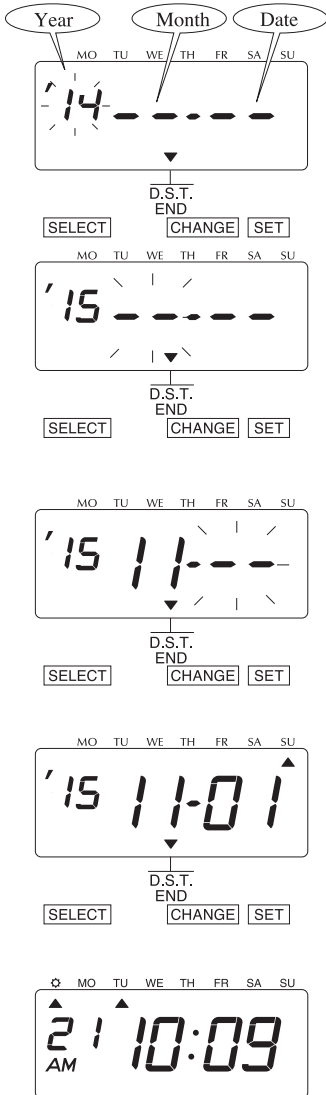

Step 1

Press the **SELECT** button and position the "▲" mark at the "D.S.T. END". At that moment, the "Year" flashes. (The flashing means it can be changed.)

Change the "Year".

In case of the example, press the **CHANGE** button to set at "15". And then press the **SET** button.

At that moment, the flashing changes from "Year" to "Month".

Step 2

Change the "Month".

Press the **CHANGE** button to set at "11". And then press the **SET** button.

At that moment, the flashing changes from "Month" to "Date".

Step 3

Change the "Date".

Press the **CHANGE** button to set at "01". And then press the **SET** button.

Step 4

After you finish setting the ending date of D.S.T., press the **SET** button once again. Now the ending date of D.S.T. setting has been completed. Replace the cover and lock.

IMPORTANT: If you do not complete Step 4, the clock will not print.

DELETING THE DAYLIGHT SAVING TIME SETTING

To delete and cancel the daylight saving time setting, change the display of "Month" of the starting setting to " -- ".

Example: Change March 8, 2015 of "D.S.T. START" and delete daylight saving time setting.

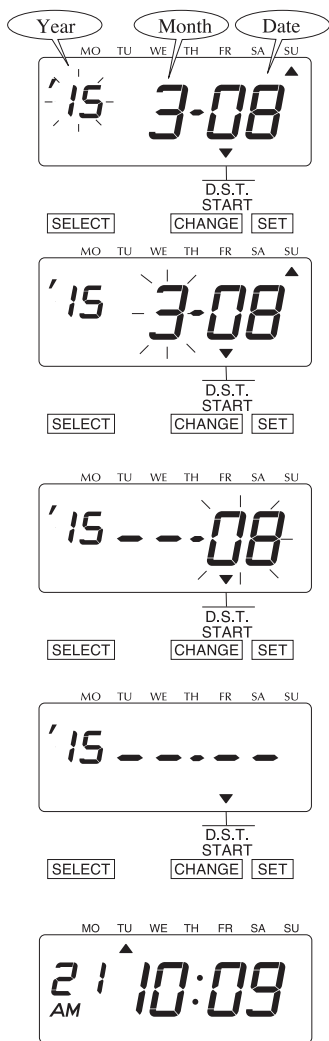

Step 1

Press the **SELECT** button and position the "▲" mark at the "D.S.T. START". At that moment, the "Year" flashes. (The flashing means it can be changed.)

Next, press the **SET** button. At that moment, the flashing changes from "Year" to "Month".

Step 2

Press the **CHANGE** button to set at " -- ". And then press the **SET** button. At that moment, the flashing changes from "Month" to "Date".

Step 3

Press the **SET** button again. At that moment, the flashing changes from "08" to " -- ".

Step 4

Press the **SET** button once again. Now the D.S.T. deleting has been completed. Replace the cover and lock.

IMPORTANT: If you do not complete Step 4, the clock will not print.

SETTING THE TIME ZONE

The Model 1600E can be set to one of the four United States time zones. Additionally, two more options including no reception of WWVB signal are available with this model. By default, the unit is shipped preset to Eastern Time.

	Order Options	
1.	Eastern	
2.	Central	
3.	Mountain	
4.	Pacific	
5.	Other	Adjusts just "minute" and "second" by the WWVB radio signal. You must set "date" and "time" to your local time first, before starting reception of the WWVB signal.
6.	No Reception	Disables atomic clock function and does not adjust time by the WWVB radio signal.

Example: Change the time zone to "Central".

Manual Initiation of Radio Reception

If you want to make the 1600E attempt to receive a radio signal without changing the current time zone, press SET button twice after Step 1 below.

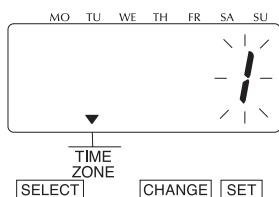

Step 1

Press the **SELECT** button and position the "▲" mark at the "TIME ZONE".

At that moment, the flashing digit indicates "Order Options" of the time zone for atomic clock function.

(The flashing number means it can be changed.)

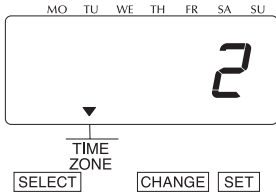

Step 2

In case of the example, press the **CHANGE** button to set at "2", and then press the **SET** button.

Step 3

After you finish setting the time zone, press the **SET** button once again. Now the time zone setting has been completed. Replace the cover and lock.

IMPORTANT: If you do not complete Step 3, the clock will not print and start reception of radio signal.

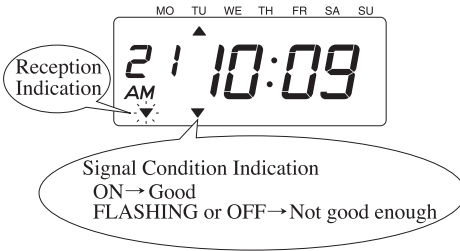

SETTING THE PASSWORD

When the password is set, you are asked to enter it. If the password you entered does not coincide with the setting, you cannot change the setting values. You may set a password by any 4-digit number from 0001 to 9998. Note a number "0000" and "9999" cannot be used as a password.

REGISTERING THE PASSWORD

Example: Set the password "1234".



PASSWORD
SELECT CHANGE SET



PASSWORD
SELECT CHANGE SET



PASSWORD
SELECT CHANGE SET



Step 1

Press the **SELECT** button and position the "▲" mark at the "PASSWORD".

At that moment, first two digits flash. (The flashing means it can be changed.)

In case of the example, press the **CHANGE** button to set at "12". And then press the **SET** button.

At that moment, the flashing changes to last two digits.

Step 2

In case of the example, press the **CHANGE** button to set at "34". And then press the **SET** button.

Step 3

After you finish registering the password, press the **SET** button once again.

Now the password registering has been completed. Replace the cover and lock.

IMPORTANT: If you do not complete Step 3, the clock will not print.

HOW TO CHANGE SETTING WHEN THE PASSWORD IS SET

Once the password is set, you have to enter the password for changing any setting. "99 99" will be displayed when you press the **SELECT** button before entering.

Example: Password "1234".

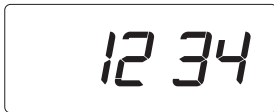

Step 1

Press the **SELECT** button, at that moment "99 99" is displayed and first two digits flashes. (The flashing means it can be changed.)

In the example, press the **CHANGE** button to set at "12". And then press the **SET** button.

At that moment, the flashing changes to last two digits.

Step 2

In case of the example, press the **CHANGE** button to set at "34". And then press the **SET** button.

At that moment, the "▲" mark indicates the "TIME".

Step 3

Select desired setting mode by pressing the **SELECT** button.

Then make settings as explained.

CANCELING THE PASSWORD

The code "00 00" must be entered to cancel the password.

Example: Cancel the password "1234".

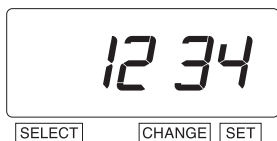
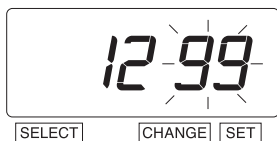
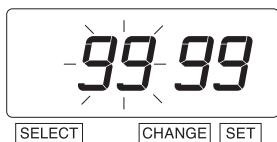

Step 1

Press the **SELECT** button, at that moment "99 99" is displayed and first two digits flashes. (The flashing means it can be changed.)

In case of the example, press the **CHANGE** button to set at "12". And then press the **SET** button.

At that moment, the flashing changes to last two digits.

Step 2

In case of the example, press the **CHANGE** button to set at "34". And then press the **SET** button.

At that moment, the "▲" mark indicates the "TIME".



PASSWORD
SELECT CHANGE SET



PASSWORD
SELECT CHANGE SET



PASSWORD
SELECT CHANGE SET



Step 3

Press the **SELECT** button and position the "▲" mark at the "PASSWORD".

At that moment, first two digits "12" flashes. (The flashing means it can be changed.)

Press the **CHANGE** button to set at "00". And then press the **SET** button.

At that moment, the flashing changes to last two digits "34".

Step 4

Press the **CHANGE** button to set at "00". And then press the **SET** button.

Step 5

After you finish canceling the password, press the **SET** button once again.

Now the password canceling has been completed. Replace the cover and lock.

IMPORTANT: If you do not complete Step 5, the clock will not print.

ADVANCED FUNCTIONS

RESETTING THE CLOCK

To return all setting to the factory defaults, push the reset switch with a pointed implement.

NOTICE: All your custom settings will be deleted and will revert to the factory defaults when the reset switch is pushed. To make new settings, please refer to "SETTING".

TURN LIGHT OFF / ON

Press and hold the SET button for approximately 3 seconds to toggle the internal light off and on.

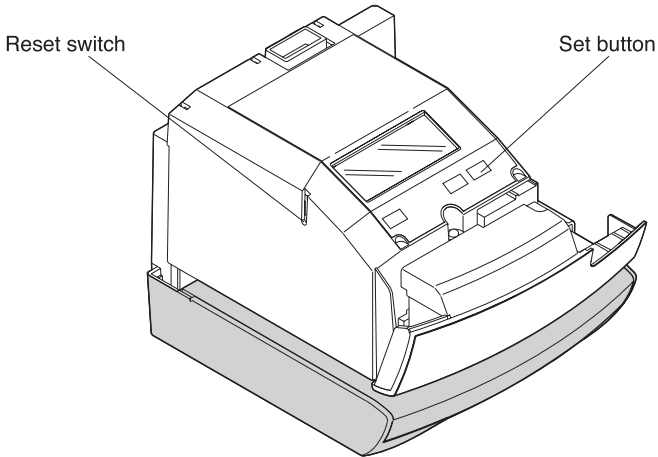

REPLACING THE RIBBON CASSETTE

CAUTION: Be sure to pull out AC cord from AC outlet before opening a cover in order to replace a ribbon cassette.

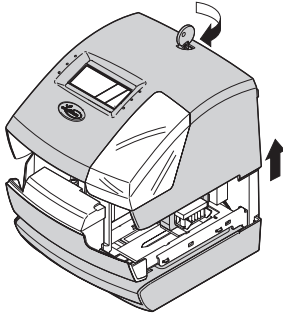

Step 1

Unlock the key and remove the cover.

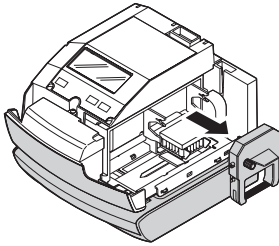

Step 2

Pick up the cassette and remove it.

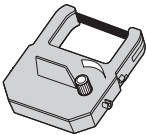

Step 3

Turn the knob of the new cassette in the direction of the arrow to tighten the ribbon.

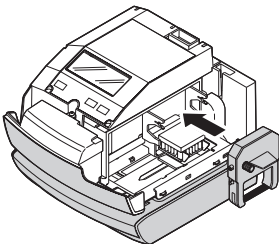

Step 4

Place the cassette inside the time clock as shown in the figure. Keep on pushing in the cassette until the clasps at both sides catch and you hear a "pop" sound. If it is difficult to insert the cassette, try it while turning the knob.

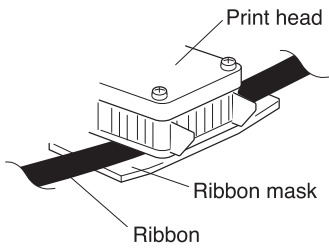

NOTICE: Install the cassette so that the ribbon is between the print head and the ribbon mask. Printing will not come out properly if the ribbon is placed behind the ribbon mask.

Step 5

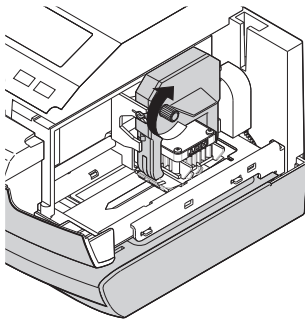

Turn the knob of the cassette in the direction of the arrow to tighten the ribbon.

Step 6

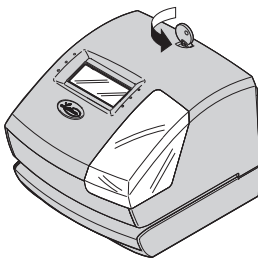

Replace the cover and lock.

RADIO SIGNAL RECEPTION

About Radio Signal Reception

The Model 1600E is programmed to see the WWVB radio signal everyday. Initially the time recorder will search for a signal immediately after you set the time zone. Once the clock has initially set, it will search for the signal 12 times per day to maintain accuracy. The WWVB signal is the strongest early in the morning, when there is the least amount of interference from other sources.

There are some environments and weather conditions that may influence the reception of the AM radio signal. Just as with an AM radio, the Model 1600E can be positioned for optimal reception. For instance, it is best to position the clock away from metal studs and toward the direction of the tower in Colorado. Since this time recorder contains a highly accurate quartz timer, it will function with a very high level of accuracy between signal receptions. The Model 1600E will operate as normal electronic time recorder without having to receive the signal. Since it is also operates as a highly accurate (+/- 15 seconds per month) quartz time clock, it will function properly while outside the reception area or if it can not receive the WWVB signal.

Signal Reception Indicator

FLASHING: Unit is receiving the atomic radio signal.

ON: Unit successfully received the atomic radio signal.

OFF: Unit was unable to receive the radio signal.

(See "Troubleshooting" section.)



Reception
indication

TROUBLESHOOTING

ERROR No. APPEARS

Refer to the following list for proper operation.

Error No.	Error contents	Action
E-00	CPU error	Contact the store from whom you bought the Time Clock, call Lathem Time directly at (800) 241-4990.
E-01	The remaining life of lithium battery for memory back-up is short.	
E-05	The card is not inserted in the clock properly.	Correctly insert the card.
E-30	Cannot print. The printer motor or home position sensor is not normal.	Make sure that the ribbon cassette is correctly inserted in place.
E-38	Cannot print. The print head motor or the sensor does not operate properly.	Press the push bar.
E-40	Incorrect password	Enter the correct password again.
E-49	Setting data you entered is not usable.	Refer to your owner's manual on the page related to the item you want to set and enter again correct setting data.

OTHER FAILURES

- **The time clock does not operate.**
Ensure the AC adapter is properly plugged into the AC outlet.
- **The time clock does not print.**
Ensure the ribbon is installed correctly.
- **The card is jammed.**
Press the push bar and try to pull out the card at the same time.
- **No signal has been received.**
 - 1) Wait for early morning hours to pass.
 - 2) Re-locate in area that is away from metal studs or close to western facing window.

Note: There are some environments and weather conditions that may influence the reception of the atomic clock radio signal. Since it also operates as a highly-accurate (+/- 15 seconds per month) quartz time clock, the 1600E will function properly while outside the reception area or if it can not receive the WWVB signal.

- **The time is exact to the minute but the hour is incorrect.**
Ensure the correct Time Zone is selected by time zone setting. You can also Disable radio reception or set to Other for minute only correction. Check the daylight saving time setting.

SPECIFICATIONS

Clock accuracy	Monthly accuracy ± 15 sec. (at ordinary temperatures)
Calendar	Year up to 2099. Automatically adjusted to leap years, 31-day months and months with thirty or fewer days, and the days of the week.
Printing system	Dot matrix imprint
Power failure compensation	Three years of cumulative power failure hours after the date of shipment.
Operating environment:	Temperature: -5° to 45° C, $+23^{\circ}$ to 113° F Humidity: 20 to 80%, no condensation The unit operates normally at temperatures of 5° C or below, but the print density, reaction of the liquid crystal display, and the number of prints at power failure are inferior to those at normal temperature operation.
Dimension	160(w) x 184(d) x 144(h) mm, 6.3"(w) x 7.2"(d) x 5.7"(h)
Weight	Approx. 1.5 kg. (1.7 kg with AC adapter)
Power consumption	120VAC $\pm 10\%$, 60Hz, 0.8A
Rating of AC adapter	I/P: 120VAC 50/60Hz 0.8A, O/P: 12VDC 3A

NOTICE: Use only the supplied AC adapter.

Limited One-Year Warranty

Lathem warrants the hardware products described in this guide against defects in material and workmanship for a period of **one year** from date of original purchase from Lathem or from an authorized Lathem reseller. The conditions of this warranty and the extent of the responsibility of Lathem Time Corporation ("Lathem") under this warranty are listed below.

1. This warranty will become void when service performed by anyone other than an approved Lathem warranty service dealer results in damage to the product.
2. This warranty does not apply to any product which has been subject to abuse, neglect, or accident, or which has had the serial number altered or removed, or which has been connected, installed, adjusted, or repaired other than in accordance with instructions furnished by Lathem.
3. This warranty does not cover dealer labor cost for removing and reinstalling the machine for repair, or any expendable parts that are readily replaced due to normal use.
4. The sole responsibility of Lathem under this warranty shall be limited to repair of this product, or replacement thereof, at the sole discretion of Lathem.
5. If it becomes necessary to send the product or any defective part to Lathem or any authorized service dealer, the product must be shipped in its original carton or equivalent, fully insured with shipping charges prepaid. Lathem will not assume any responsibility for any loss or damage incurred in shipping.
6. **WARRANTY DISCLAIMER AND LIMITATION OF LIABILITY:** Except only the limited express warranty set forth above, the products are sold with no expressed or implied warranties of any kind, and the implied warranties of merchantability and fitness for a particular purpose are hereby expressly disclaimed. No warranties are given with respect to products purchased other than from Lathem or an authorized Lathem reseller and any such products are purchased "as is, with all faults." In no event will Lathem be liable for any direct, indirect, special, incidental or consequential damages arising out of or in connection with the delivery, use or inability to use, or performance of this product. In the event any limited remedy given herein shall be deemed to have failed of its essential purpose, Lathem's maximum liability shall be to refund the purchase price upon return of the product.
7. Proof of date of purchase from Lathem or an authorized Lathem reseller is required for warranty service on this product.
8. This Warranty grants specific legal rights. Additional legal rights, which may vary by locale, may also apply.
9. Should any difficulties arise with the performance of this product during warranty, or with any Lathem authorized service centers, contact Lathem Time at the address below.

Lathem Time | 200 Selig Drive, SW, Atlanta, GA 30336 | 404-691-0405

Leave ~ 1/4" gap between wall and screw head.
See Page 5 for instructions.



Wall Mount Template

