

70000E

User's Manual

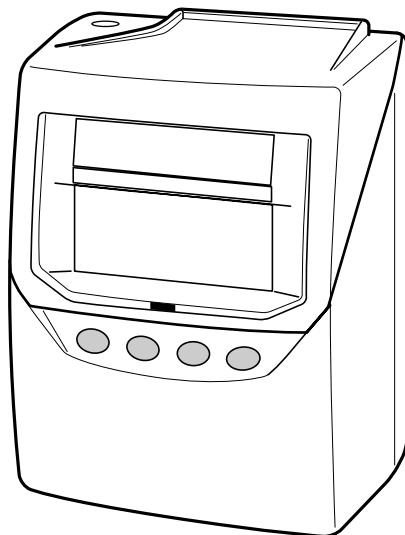

Lathem Time Corporation

WARNING

This equipment has been tested and found to comply with the limits for a Class A digital device, pursuant to Part 15 of FCC Rules. These limits are designed to provide reasonable protection against harmful interference when the equipment is operated in a commercial environment. This equipment generates, uses, and can radiate radio frequency energy and, if not installed and used in accordance with the instruction manual, may cause harmful interference to radio communications. Operation of this equipment in a residential area is likely to cause harmful interference in which case the user will be required to correct the interference at his or her own expense.

Caution: Changes or modifications not expressly approved by the party responsible for compliance could void the user's authority to operate the equipment.

THIS DIGITAL APPARATUS DOES NOT EXCEED THE CLASS A LIMITS FOR RADIO NOISE EMISSIONS FROM DIGITAL APPARATUS AS SET OUT IN THE RADIO INTERFERENCE REGULATIONS OF THE CANADIAN DEPARTMENT OF COMMUNICATIONS.

LE PRÉSENT APPAREIL NUMÉRIQUE N'ÉMET PAS DE BRUITS RADIOÉLECTRIQUES DÉPASSANT LES LIMITES APPLICABLES AUX APPAREILS NUMÉRIQUES DE CLASSE A PRESCRITES DANS LE RÈGLEMENT SUR LE BROUILLAGE RADIOÉLECTRIQUE ÉDICTÉ PAR LE MINISTÈRE DES COMMUNICATIONS DU CANADA.

1. The details of this User's Manual are subject to change even without previous notification.
2. This User's Manual has been prepared with the utmost care to cover all aspects of the time clock's use.
3. Be sure to use your time clock after you have fully understood the hardware and software specifications and limits.
4. No part of this publication may be reproduced, stored in a retrieval system, or transmitted, in any form or by any means, mechanical, photocopying, recording or otherwise.

This User's Manual and its contents are copyrighted by LATHEM TIME CORP. with all rights reserved.



Lathem Time Corporation

www.lathem.com

(800) 241-4990

(404) 691-1065

TABLE OF CONTENTS



1. PRECAUTIONS	1
2. FEATURES	3
3. BEFORE USING TIME RECORDER	4
Accessories	4
Features	4
Installing Ribbon Cassette	5
Mounting Unit on Wall	7
Environmental Conditions	7
4. DAILY OPERATIONS	8
Functions for the buttons	9
Required / Optional / Disabled	9
Card reassign	10
All cards reset	11
Card reset	12
5. WHAT YOU CAN DO WITH THE 7000E	14
6. SETTING	16
Preparation for setting	16
Setting the Display Hours	17
Setting the Time	18
Setting the Date	19
Setting the Mode	20
Payroll Mode	20
Job Cost Mode	23
Setting the Print Format	24
Setting the Rounding	26
Setting the Auto Break Deduction	27
Setting the Max In	28
Setting the Button Function	29
Setting the Daylight Saving Time	30
Deleting the daylight saving time settings	33
Setting the Print Language	34
Resetting	35
7. PRINT EXAMPLE	36
8. INSTALLING Ni-Cd BATTERY (Optional)	37
9. TROUBLESHOOTING	38
10. SPECIFICATIONS	39





1. PRECAUTIONS







This operation manual is prepared for safe and proper use of the unit. Please follow all the instructions to avoid possible danger to yourself or others and damage to the unit.



Signs

Various warnings and cautions are provided throughout this manual along with signs. Remember each sign and its explanation listed below for your safety and proper operation of the unit.











 Warning	Improper handling may cause bodily accidents including death and serious injury.
 Caution	Improper handling may harm the human body or material.

 Improper handling may cause electric shock DANGER.	 "Must-Do" sign.
 DO NOT disassemble the unit.	 Be sure to remove the line cord plug from the outlet.
 "Don't" sign.	

 Warning	
 Do not disassemble the unit. There is a high voltage present inside, possibly leading to an electric shock.	
 Do not modify the unit. Modifications may cause a fire and/or electric shock.	
 If any anomaly occurs, for example, heat or smoke is generated or an odor is emitted, unplug the unit immediately and contact your dealer for servicing. There is a danger that further use may cause a fire or electric shock.	
 Do not use any voltage of the power source other than designated. Do not share a single outlet with another plug. These may lead to fire or shock hazards.	
 Do not damage, break, or modify the power cord. Do not put a heavy object on, pull, or forcefully bend the cord, either. These may damage the cord, possibly resulting in a fire or electric shock.	

-  If foreign matter should get in the unit (including a piece of metal, water, or liquid), disconnect the plug from the outlet immediately and contact your dealer for servicing. There is a danger that further use may cause a fire or electric shock.
-  Do not plug or unplug the unit with a wet hand. You may get an electric shock.

 **Caution**

-  Do not place the unit on an uneven or tilted surface. This may result in injuries due to the unit dropping or falling off.
-  Do not put a water-filled container or a metal object on top of the unit. If water is spilled or the metallic object slips inside, a fire or shock hazard may occur.
-  Do not install the unit in a humid or dusty environment. It may cause a fire or electric shock.
-  Do not place the unit near kitchen counter or humidifier. Oil, smoke, or steam generating from them may cause fire or shock hazards.
-  Do not yank the power cord to disconnect from the outlet. Hold the plug with your hand to do so, or the cord may be damaged, possibly leading to a fire or electric shock.
-  Remove the line cord plug from the outlet before transferring the unit, or it may damage the cord, possibly leading to a fire or electric shock.
-  Be careful not to contact the print head, as you may get hurt or burned.
-  Make sure to insert the power plug as far as it will go. Improper insertion of the plug may develop fire or shock hazards.
-  Do not insert or drop any other time card than specified into the slot. Such misuse may cause a fire or electric shock.
-  If the unit should be dropped or the case be broken, unplug the unit and contact your dealer for servicing. Further use may lead to a fire or shock hazard.

Daily Care
 For cleaning, turn the power off and wipe the case clean of dust and dirt with a dry cloth, etc.

2. FEATURES

This time recorder will provide automatic alignment and basic calculation of total hours. This time recorder will utilize time cards pre-encoded with a bar code and numbered 1 through 100. The time recorder is designed for small businesses as a fast and efficient way to track time for Payroll and Job Costing.

- Automatic top-feed time recorder aligns registrations on time card.
- Prints IN (Start) and OUT (Stop) dates and times.
- The recorder can operate in one of 2 modes;
 Payroll Mode / Job Cost Mode
- The recorder prints total elapsed time between registrations and also prints a running total of accumulated time per time card on each line.
- In order to properly identify missed punches, the recorder has a "Max In" value that is used to pair punches for calculations.
- The number of cards that can be automatically registered is a maximum of 50 cards.
- The functions for the buttons on the front of the recorder can be set. There are 3 options;
 Required / Optional / Disabled
- Automatic Daylight Savings adjustment
- The languages English·Spanish·French can be selected to print "Month" and "the days of the week".
- The clock can be either wall or table mounted.

You can usually obtain technical support and order accessories from the store where you bought the clock. To contact Lathem, go on-line to www.lathem.com or call 800-241-4990 (404-691-1065 outside USA).

3. BEFORE USING TIME RECORDER

Accessories

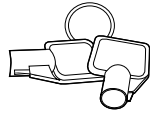

Keys

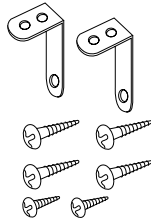

Wall mount hardware

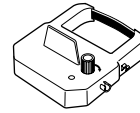

Ribbon cassette
Part No. VIS6008

MUST USE THE E7 SERIES CARD FROM LATHEM TO INSURE PROPER OPERATION.
An optional battery is sold separately (Part No. VIS 6020) to provide 100% operation of card print mechanism during power failures.

Features

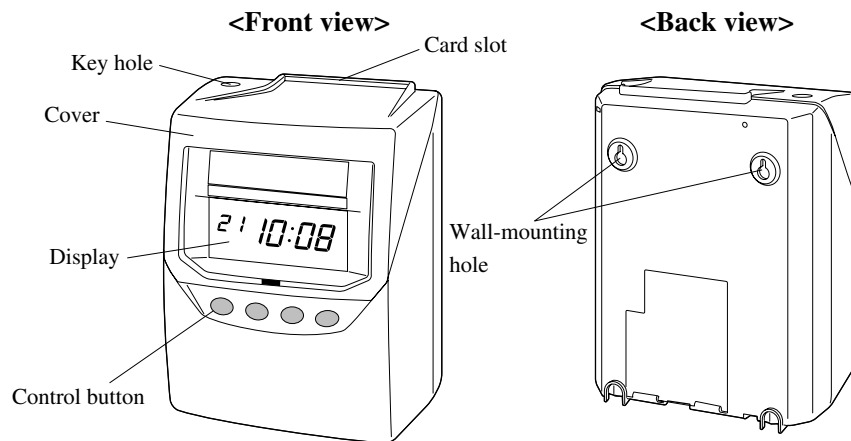

< Display >

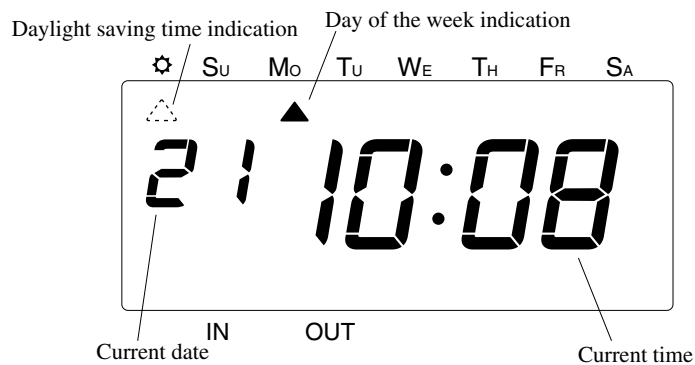

Installing Ribbon Cassette

Make sure the power is on before installing.

- 1 Hold the left and right sides of the cover and lift up.

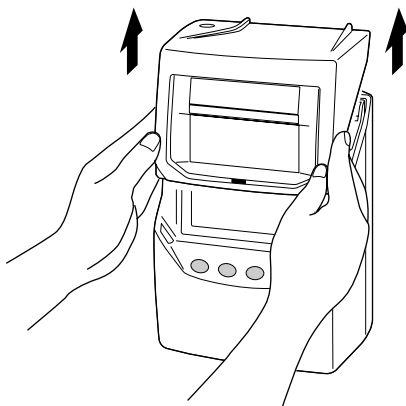

- 2 Turn the knob of the new ribbon cassette in the same direction as the arrow to tighten the ribbon.

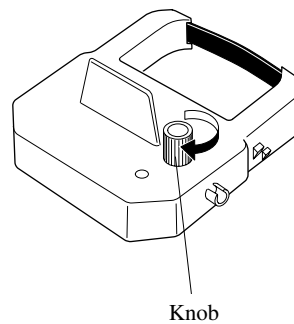

- 3 Place the ribbon cassette inside the time recorder as shown in the figure. Push the ribbon cassette until it snaps into the clasps on both sides. If it is difficult to insert the ribbon cassette, try it while turning the knob.

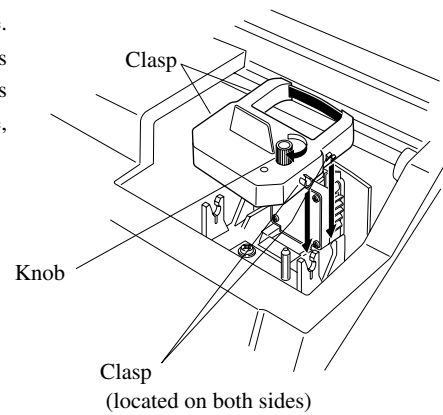

4 Precautions to take when replacing the ribbon

Take the following precautions when inserting a new ribbon cassette.

Install the ribbon cassette so that the ribbon is between the print head and the ribbon mask (see the figure on the left). Printing will not come out properly if the ribbon is placed behind the ribbon mask (see the figure on the right).

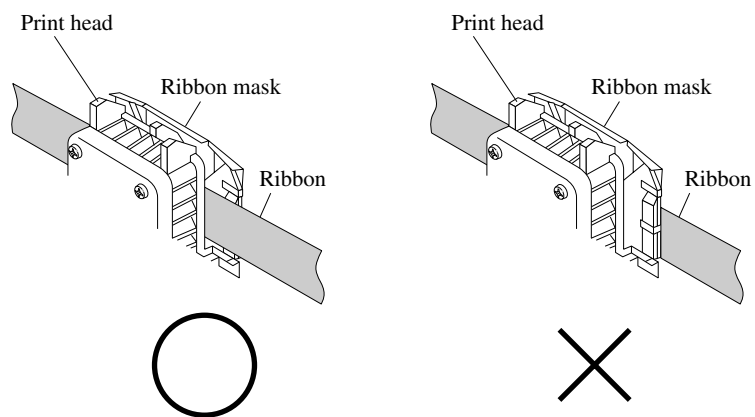

- 5** Turn the knob of the ribbon cassette in the direction of the arrow to tighten the ribbon.

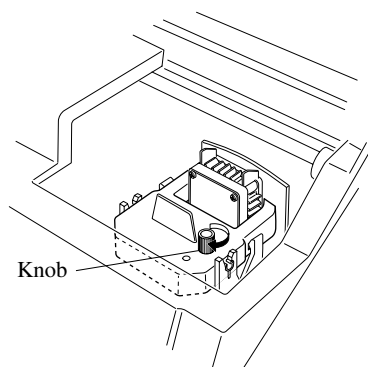

- 6** Replace the cover by fitting the plugs at both sides of the cover into the holes located on the unit of the body, and while pulling the cover toward yourself, push down.

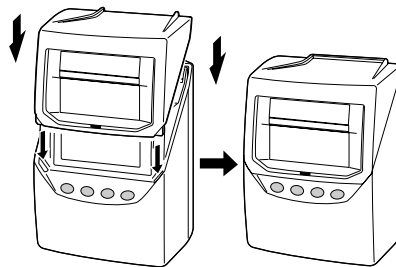

Mounting Unit on Wall

The unit can be mounted on a wall using the supplied mounting fittings. To mount the unit on a wall, take the following steps:

- 1 Install wall mount screws (supplied) into a wall 3.94 inches (10 cm) apart. Be sure to keep about 0.12 inch (3 mm) of the screw head out of the wall.

! The supplied screws are intended for use on a thick wooden wall or wooden column. Do not use them on any other materials. There is a danger that the unit may come off if used on other materials.

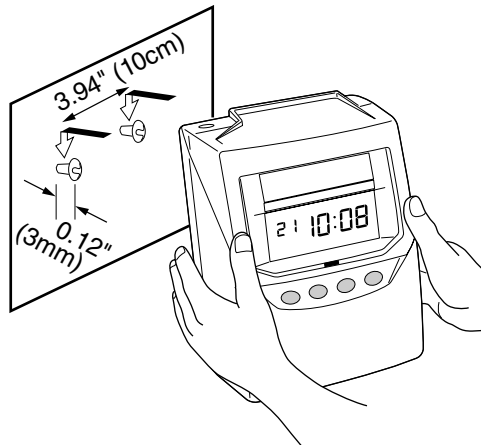

- 2 Mount the wall mount fittings as shown on the right.

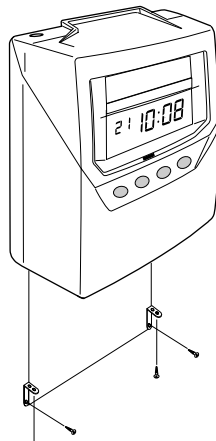

Environmental Conditions

Avoid placing the unit in environments that are:

- humid or dusty
- exposed to direct sunshine
- subject to frequent or continuous vibrations
- outside the temperature range between 23°F (-5°C) and 113°F (45°C)
- affected by chemicals or ozone

4. DAILY OPERATIONS

Once the AC line cord is plugged into the outlet, the recorder can be used immediately. Basic operations, including the time and dates are preset.

It is easy to operate the unit. The time card is automatically pulled in, printed and then ejected.

Refer to "3.BEFORE USING TIME RECORDER".



Do not let any metallic object get into the slot including paper clips. Do not forcefully push in a card, either. These may cause the unit to malfunction.

- The number of cards that can be automatically registered is a maximum of 50 cards.
- When a new card is inserted, the card will automatically be registered, and will print the "IN" print on the first line. The month will be printed on the first line also or on the line when the month and printing line change.
- You can print "IN" and "OUT" as many times as you want per day. Concerning the printing line, it will slide one line down each time you insert the card for "IN" print.
- You can choose 3 functions for the buttons. You must set these modes before inserting any card in order for it to be valid.

Refer to "Functions for the buttons".

- When the card that you are using becomes full, it will show "END" on the display. When the "END" appears, you can use the "Card reassign" mode to transfer the card and have a new card take over from the old one.

Refer to "Card reassign".

- When you want to reset the card (clear the accumulated totals) manually, you can use the "Card reset" mode to reset a single card or use the "All cards reset" mode to reset all the cards in memory. It is not necessary to routinely reset cards manually, since the clock does this automatically each pay period (unless using Job Cost Mode).

Refer to "Card reset" and "All cards reset".

Functions for the buttons

You can select one of three functions for the buttons.

Required

You must push the "IN" or "OUT" button immediately prior to inserting the time card. If not, the card will be ejected and an error sign will appear.

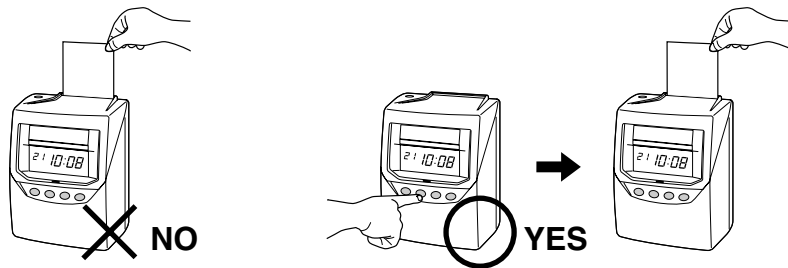

Optional

When the time card is inserted, the recorder will judge the last imprint and automatically switch the "IN" and "OUT". You may also manually switch the column position of the imprint by pushing the button.

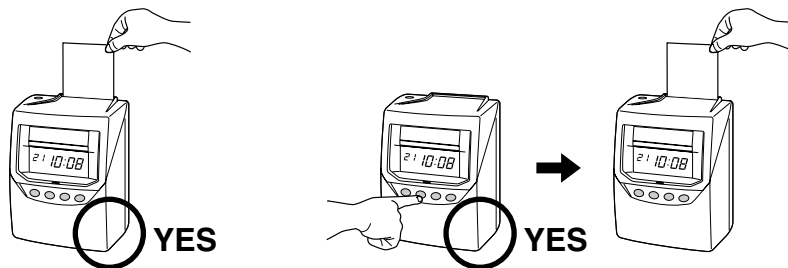

Disabled

When the time card is inserted, the recorder will judge the last imprint and automatically switch the "IN" and "OUT". The buttons are disabled for normal operation.

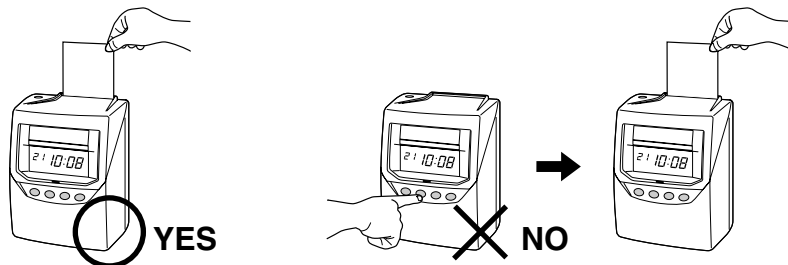



Card reassign

When the card that you are using becomes full (Max 64 punches), it will show "END" on the display and the buzzer will sound. When the "END" appears, you can use the "Card reassign" mode to transfer the card and have a new card take over from the old one.

In this function, it will be useful.....

- when the card has become full before reaching the "Pay Period". [In Payroll Mode]
- when the card that is lost or damaged.

Example

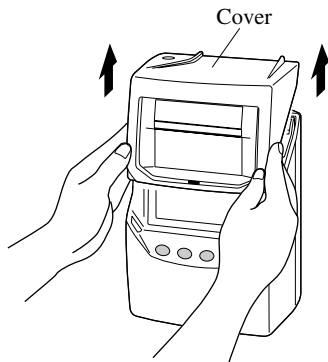
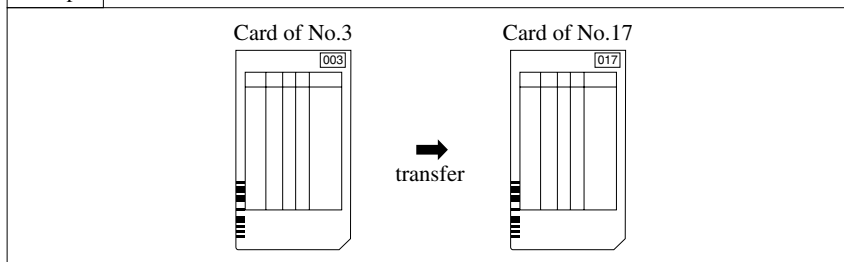

1 Remove the cover.

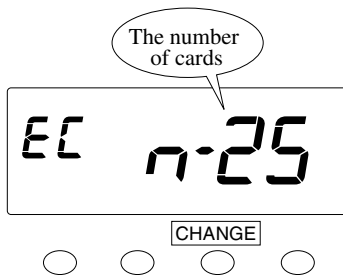

2 Push the **CHANGE** button for 3 seconds.

When you have a card that you are using, the number of cards that you are using will be shown on the display. If there are no cards used at the present state, it will show "n-00" and will end the mode.

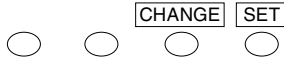

CHANGE SET

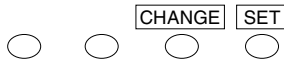
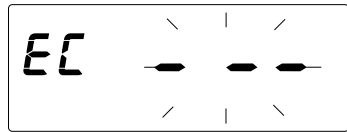

CHANGE SET

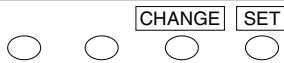

CHANGE SET

3 After the numbers of cards are shown, in the example, insert the card "003" or push the **CHANGE** button to show the card number "003" and then push the **SET** button.

4 Next insert the card "017" or push the **CHANGE** button to pick a new card number "017" and then push the **SET** button. When the card number is changed, this mode will finish.

All cards reset

You want to reset all cards manually.....

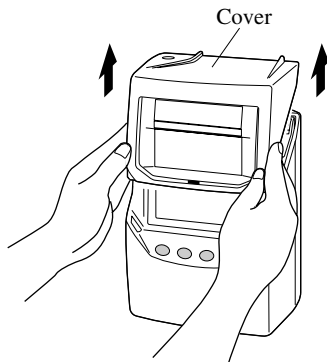

1 Remove the cover.

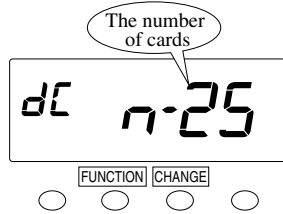

2 Push the **FUNCTION** and **CHANGE** button for 3 seconds. The number of cards that you are using will be shown on the display.

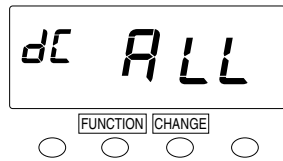

3 Push the **CHANGE** button to show "ALL" and then push the **SET** button.

4 Push the **SET** button one more time.

Card reset

If you want to reset the card manually before the end of pay period, you can use the "Card reset" mode.

Example: The number of the card you want to reset is "003".

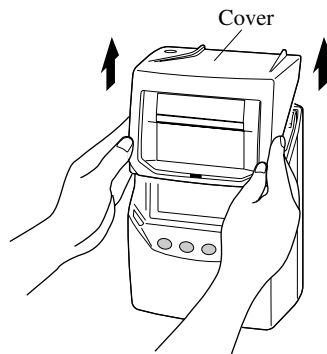

1 Remove the cover.

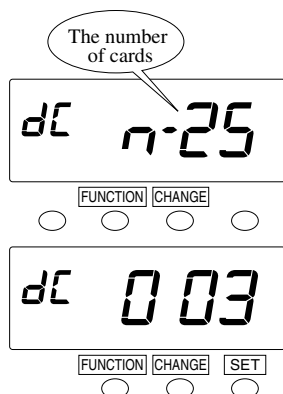

2 Push the **FUNCTION** and **CHANGE** button for 3 seconds. The number of cards that you are using will be shown on the display.

3 In the example, insert the card "003" or push the **CHANGE** button to show the card number "003" and then push the **SET** button.

4 Push the **SET** button.

12



You can reset the card without removing the cover when the time recorder is used under the following condition.

- The Job Cost Mode and also the card "Reset" setting is YES.

Refer to "Job Cost Mode" in "Setting the Mode".

In order to reset the card, you must push the right-side button (Reset button) and then insert the card.

After printing "RESET", the card shall be ejected.

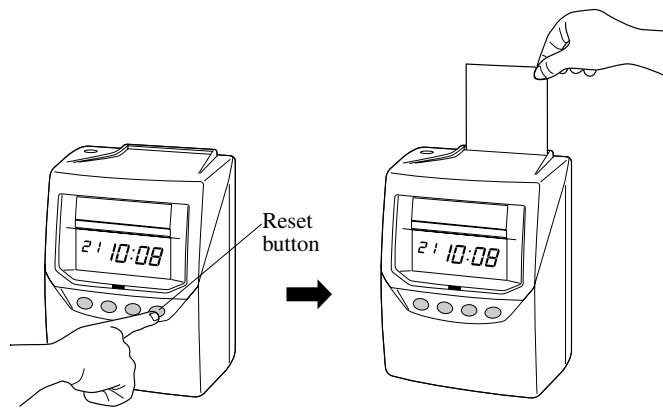

Note: If the last punch was IN, you must insert the card twice.

A fully used card can also be reset by this operation, but without printing the word "RESET".

5. WHAT YOU CAN DO WITH 7000E

- This time recorder can operate in one of two modes; Payroll Mode or Job Cost Mode. In Payroll Mode and Job Cost Mode, the recorder prints total elapsed time between IN(Start) and OUT(Stop), and also prints a running total of accumulated time per time card on each line. The clock matches pairs of punches and calculates the elapsed time between that pair using predefined rounding rules. The recorder always prints the actual time on the time card, regardless of rounding rules. In Payroll Mode the hours accumulate and reset based on "pay period settings" that are configured during setup. In Job Cost Mode the hours for each unique card can accumulate and reset based on "manual card reset" ("cleared") by performing a manual operation on the time recorder.
- For Rounding, there are two options; **Hourly Rounding, Punch Time Rounding**. For Hourly Rounding, the recorder calculates the hours from time IN punch and time OUT punch, and rounds that result with the "Rounding Unit". The fractions that occur after rounding will be omitted by breakpoint. For Punch Time Rounding, the recorder rounds both the time IN punch and the time OUT punch, and then it calculates the hours from the time IN punch and the time OUT punch. When rounding the time IN punch, it will raise the fractions that occur and, for the rounding of the time OUT punch, it will omit the fractions by breakpoint.
- The functions for the buttons on the front of the recorder can be set. There are three options; Required, Optional, Disabled.

Refer to "Functions for the buttons".

- In order to properly identify missed punches, the recorder has Max In Value that is used to pair punches for calculations. If the next punch following an IN punch exceeds the Max In Value(i.e.,13hrs.), then it assumed that the employee forgot to punch OUT, and that punch is actually printed as the next IN punch. The employee can override this and force the recorder to make OUT punch by pressing the OUT button before inserting the time card. The buttons must be enabled. (See "Setting the Button Function".)



- Break times can be automatically deducted from totals using the "Auto Break Deduction" feature. You must set a base working elapsed time and break duration. Once total working hours reaches to Elapsed Time, Break Duration will be deducted from the total working hours.

Example: Auto Break Deduction setting
Elapsed time ... 8 hours Break duration ... 60 min.

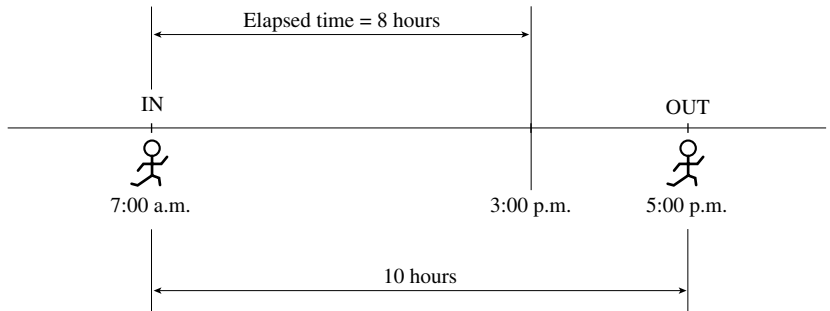

Auto Break Duration setting	Print example		
	IN	OUT	TOTAL
Yes	7:00 A	5:00 P	9:00 B
No	7:00 A	5:00 P	10:00 B

"B" is to indicate that Auto Break Deduction is valid.

6. SETTING

Preparation for setting

To prepare for setting:

! Make sure the power is on before making setting.

1 Unlock the cover.

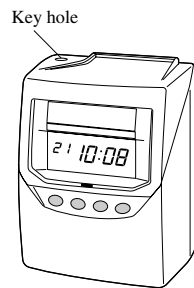

2 Hold the sides of the cover with both hands, and lift it.

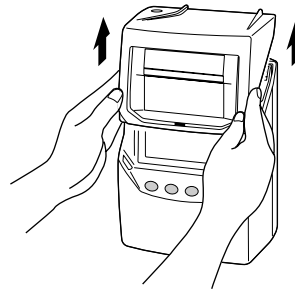

3 Make settings using the control button while watching the display. Please refer to the following page for the details of each setting.

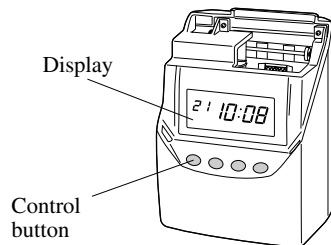

4 After the setting has been completed, fit the plugs at the lower sides of the cover into the holes of the unit.

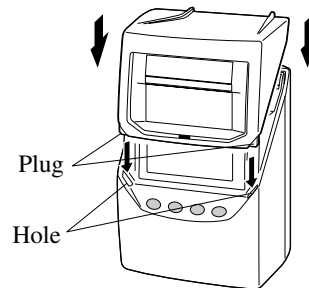

5 Pull back the cover while returning it from your side to the opposite side to install it.

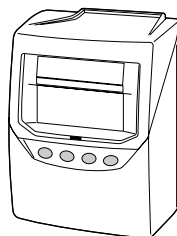

Setting the Display Hours

	Type of hour
1	AM/PM (12hour)
2	24 hour

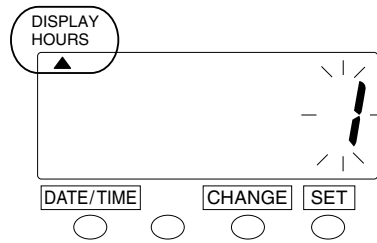

1 Push the **DATE/TIME** button for 3 seconds and position the "▲" under the "DISPLAY HOURS" mark.

2 Push the **CHANGE** button to select either "AM/PM" or "24 hour". For example, set 1 if AM/PM hour is desired.

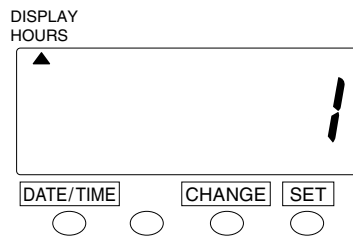

3 Push the **SET** button to finish the setting. At that moment, the display will change from flashing to steady, and the setting is now completed.

4 Push the **SET** button once again.

Setting the Time

Example

Change the time from 10:08 a.m. to 10:09 a.m.

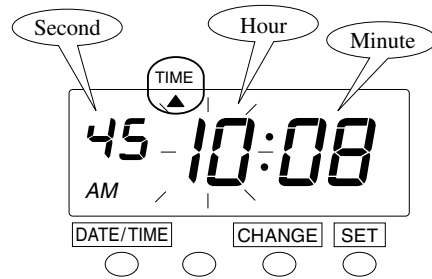

1 Push the **DATE/TIME** button for 3 seconds.

2 Push the **DATE/TIME** button and position the "▲" under the "TIME" mark.

The flashing number can be changed.

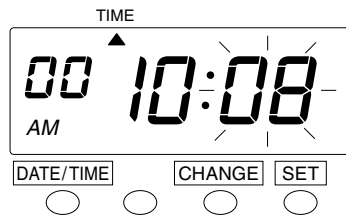

3 In the example, push the **SET** button because the hour is not to be changed; now the hour of 10 o'clock has been set.

At that moment, the flashing of the display changes from "Hour" to "Minute".

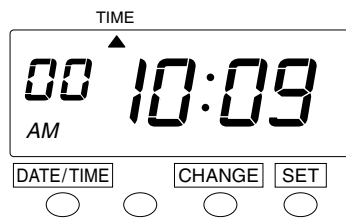

4 Changing the "Minute" (for example, from 8 minutes to 9 minutes).

Push the **CHANGE** button to set "Minute" at "09" and then push the **SET** button. Now the minutes of 9 have been set.

5 Push the **SET** button once again.

Setting the Date

Example

Change the date from October 20, 2002 to October 21, 2002.

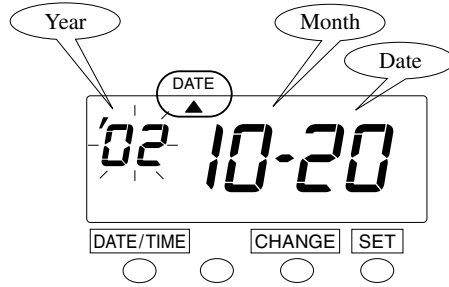

1 Push the **DATE/TIME** button for 3 seconds.

2 Push the **DATE/TIME** button and position the "▲" under the "DATE" mark.

A flashing number means that it can be changed.

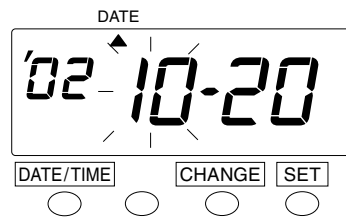

3 In the example, push the **SET** button because the year 2002 is not to be changed. Now the year of 2002 has been set.

At that moment, the flashing of the display will change from "Year" to "Month".

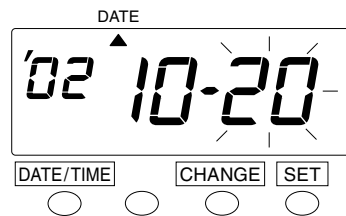

4 In the example, push the **SET** button because the month of October is not to be changed. Now October has been set.

At that moment, the flashing of the display will change from "Month" to "Date".

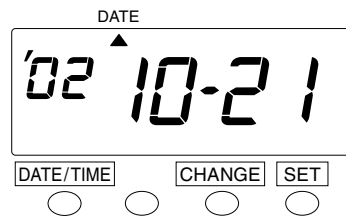

5 Change "Date" (for example, from 20 to 21)

Push the **CHANGE** button to set "Date" at "21" and then push the **SET** button, and now the date of 21 has been set.

At that moment, "Date" on the display will change from flashing to steady, and the date change setting is now completed.

6 Push the **SET** button once again.

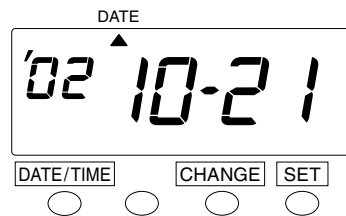

Setting the Mode

Refer to "WHAT YOU CAN DO WITH THE 7000E" before setting.
You can choose 2 types of mode, PAYROLL and JOB COST.

If error " E-49 " appears when you try to change settings, then you must reset all cards before proceeding. (See "All cards reset")

	Order Option
1	Monthly
2	Weekly
3	Biweekly
4	Semimonthly
5	JOB COST

Payroll Mode (points to options 1-4)

Job Cost Mode (points to option 5)

Payroll Mode

The unit has 4 types of pay period. You can select one of these periods. To set the pay period, you have to input a starting day of the week or date.

- When you want weekly or biweekly closing, you have to set a starting day of the week.
- When you want monthly or semimonthly closing, you have to set a starting date.

Example 1

Weekly closing (Biweekly closing) in Payroll Mode ----- the closing day is Sunday.

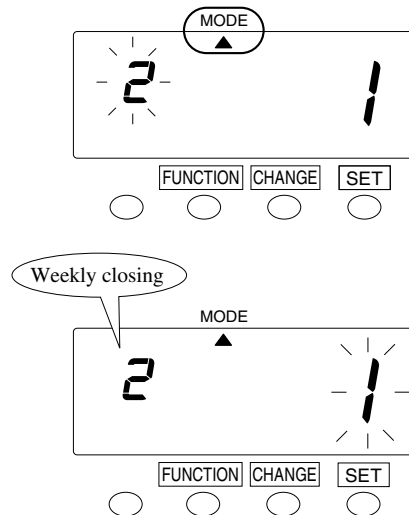

- 1** Push the **FUNCTION** button for 3 seconds and position the "▲" under the "MODE" mark.

Set the "Mode".

- 2** In the case of weekly closing, push the **CHANGE** button to set the left-side number at "2" (Biweekly closing ; set the left-side number at "3".) and then push the **SET** button. At that moment, the flashing of the display will change to the right-side number.



Set the "Starting day of the week".

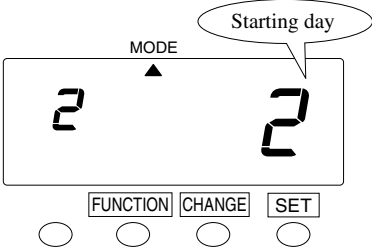

3 Starting day

1	Sunday	5	Thursday
2	Monday	6	Friday
3	Tuesday	7	Saturday
4	Wednesday		

To set pay period, you have to input a starting day. In this case, as closing day is Sunday, you have to set Monday.

Push the **CHANGE** button to set at "2" and then push the **SET** button.

4 Push the **SET** button once again.

Example 2
Monthly closing in Payroll Mode ----- the closing date is 20th.

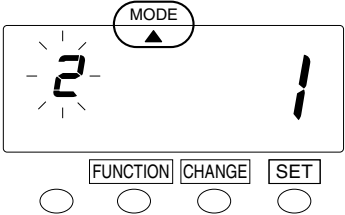

1 Push the **FUNCTION** button for 3 seconds and position the "▲" under the "MODE" mark.

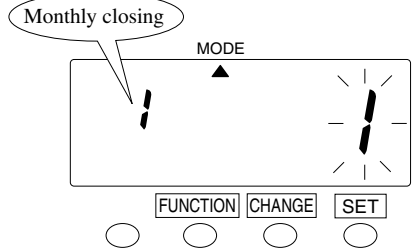

Set the "Mode".

2 In the case of monthly closing, push the **CHANGE** button to set the left-side number at "1" and then push the **SET** button. At that moment, the flashing of the display will change to the right-side number.

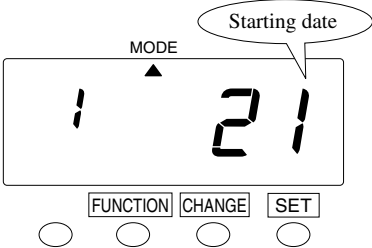

Set the "Starting date".

3 To set pay period, you have to input a starting date. In this case, as closing date is 20th, you have to set 21st. Push the **CHANGE** button to set at "21" and then push the **SET** button.

4 Push the **SET** button once again.



Example 3
Semimonthly closing in Payroll Mode ----- the starting dates are 1st and 16th.

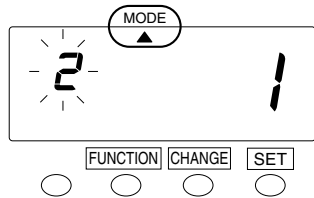

- 1 Push the **FUNCTION** button for 3 seconds and position the "▲" under the "MODE" mark.

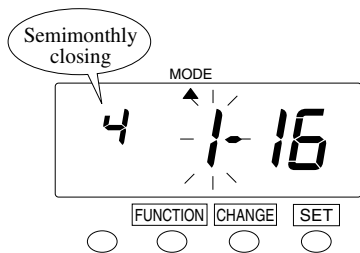

Set the "Mode".

- 2 In the case of semimonthly closing, push the **CHANGE** button to set the left-side number at "4" and then push the **SET** button. At that moment, the flashing of the display will change to the middle number.

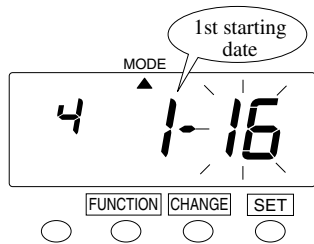

Set the "1st starting date".

- 3 To set pay period, you have to input a starting date. In this case, the 1st starting date is 1st. Push the **CHANGE** button to set at "1" and then push the **SET** button. At that moment, the flashing of the display will change to the right-side number.

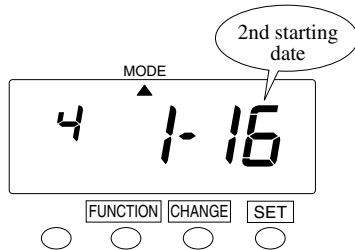

Set the "2nd starting date".

- 4 In this case, the 2nd starting date is 16th. Push the **CHANGE** button to set at "16" and then push the **SET** button.
- 5 Push the **SET** button once again.

Job Cost Mode

This mode is basically the same as Payroll Mode, but has no pay period. After punching 64 times, the end sign appears.

If you want to reset the card manually without removing the cover, you must select "Reset is YES".

Example
Card "Reset" is YES.

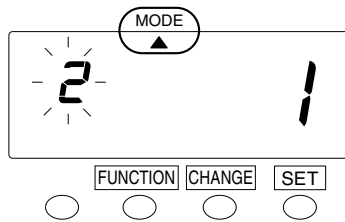

- 1 Push the **FUNCTION** button for 3 seconds and position the "▲" under the "MODE" mark.

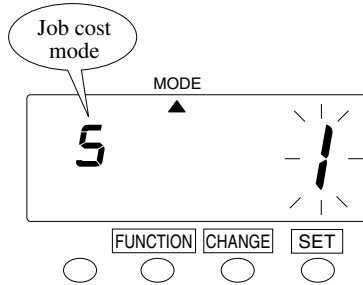

Set the "Mode".

- 2 Push the **CHANGE** button to set the left-side number at "5" and then push the **SET** button. At that moment, the display will change to the right-side number.

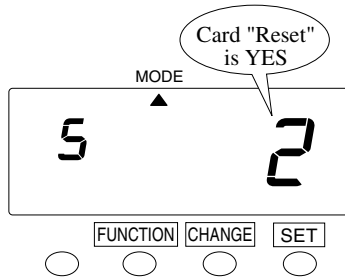

Set the card "Reset".

	Card "Reset"
1	No
2	Yes

- 3 In this case, push the **CHANGE** button to set at "2" and then push the **SET** button.
- 4 Push the **SET** button once again.

Setting the Print Format

You can select the following "Print Format".

- "Date" or "Day of the week" print format
- "AM/PM" or "24 HR" hour print format
- "Regular" or "Hundredths" minutes print format

When you have cards that you are using-----

If error " E-49 " appears when you try to change settings, then you must reset all cards before proceeding. (See "All cards reset")

Example

"Day of the week" + "AM/PM" hour + "Regular" minutes

Example of printing ----- FR 4:30P

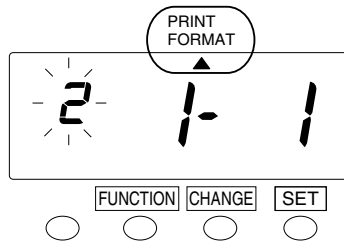

1 Push the **FUNCTION** button for 3 seconds.

2 Push the **FUNCTION** button and position the "▲" under the "PRINT FORMAT" mark.

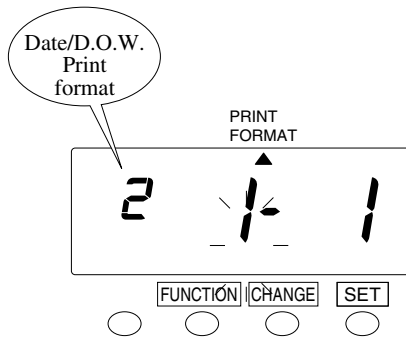

Set the "Date/D.O.W." print format.

	Order Option
1	Date
2	Day of the week

3 In this example, push the **CHANGE** button to set the left-side number at "2" and then push the **SET** button. At that moment, the flashing of the display will change to the middle number.

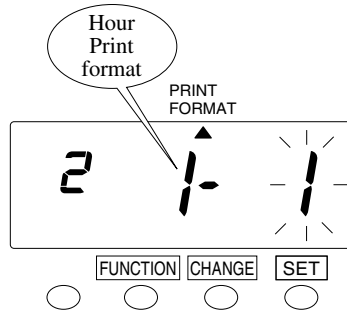

Set the "Hour" print format.

	Order Option
1	AM/PM
2	24 hour

- 4** In this case, push the **CHANGE** button to set at "1" and then push the **SET** button. At that moment, the flashing of the display will change to the right-side number.

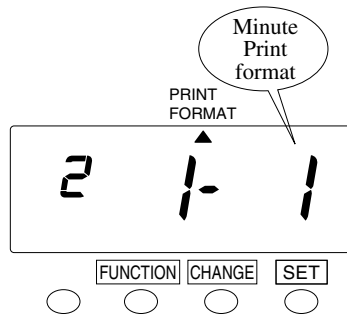

Set the "Minute" print format for totals only.

Punch times only show in minutes.

	Order Option
1	Regular minutes
2	Hundredths

- 5** In this case, push the **CHANGE** button to set at "1" and then push the **SET** button.
- 6** Push the **SET** button once again.

Setting the Rounding

Refer to "WHAT YOU CAN DO WITH THE 7000E" before setting.

If error " E-49 " appears when you try to change settings, then you must reset all cards before proceeding. (See "All cards reset")

Example

Types of rounding ----- Punch Rounding unit ----- 15 min.- 7 breakpoint

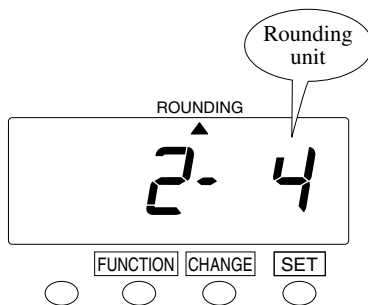
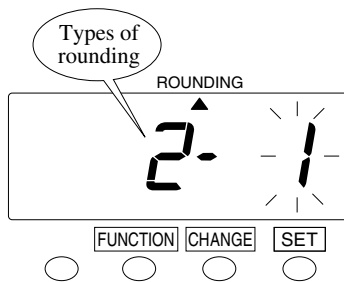
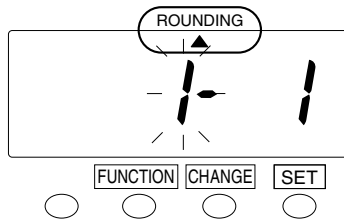

- 1 Push the **FUNCTION** button for 3 seconds.
- 2 Push the **FUNCTION** button and position the "▲" under the "ROUNDING" mark.

Set the "Types of rounding".

	Order Option
1	Hours (Hourly rounding)
2	Punch (Punch time rounding)

- 3 In the case of the example, push the **CHANGE** button to set the left-side number at "2" and then push the **SET** button. At that moment, the flashing of the display will change to the right-side number.

Set the "Rounding unit".

	Order Option
1	None
2	6 minute 3 breakpoint
3	15 minute 3 breakpoint
4	15 minute 7 breakpoint

- 4 In this case, push the **CHANGE** button to set at "4" and then push the **SET** button.
- 5 Push the **SET** button once again.

Setting the Auto Break Deduction

Refer to "WHAT YOU CAN DO WITH THE 7000E" before setting.

If error " E-49 " appears when you try to change settings, then you must reset all cards before proceeding. (See "All cards reset")

Example
Elapsed time ----- 8 hours Break duration ----- 60 min.

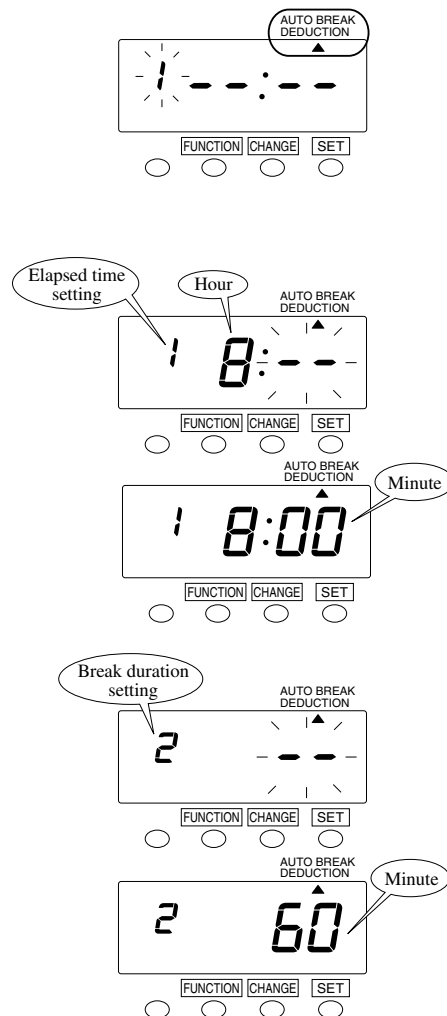

	Order Option
1	Elapsed time
2	Break duration

- 1** Push the **FUNCTION** button for 3 seconds.
- 2** Push the **FUNCTION** button and position the "▲" under the "AUTO BREAK DEDUCTION" mark.

Set the "Elapsed time".

- 3** Push the **SET** button. At that moment, the flashing changes to "Hour". In the case of the example, push the **CHANGE** button to set at "8" and then push the **SET** button. At that moment, the flashing of the display will change from "Hour" to "Minute".
- 4** In this case, push the **CHANGE** button to set at "00". And then push the **SET** button.

Set the "Break duration".

- 5** Push the **CHANGE** button twice to set the left-side number at "2" and then push the **SET** button. At that moment, the flashing of the display will change to "Minute".
- 6** In this case, push the **CHANGE** button to set at "60". And then push the **SET** button.

Range of value: 1 - 90 min.

- 7** Push the **SET** button once again.

Setting the Max In

Refer to "WHAT YOU CAN DO WITH THE 7000E" before setting.

You can set the "Max In Value" and "Max In Override".

If error " E-49 " appears when you try to change settings, then you must reset all cards before proceeding. (See "All cards reset")

Example

Max In Override ----- No Max In Value ----- 17 hours

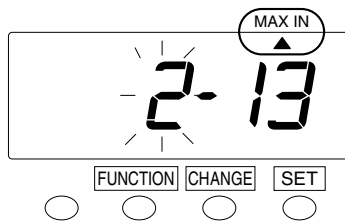

- 1 Push the **FUNCTION** button for 3 seconds.
- 2 Push the **FUNCTION** button and position the "▲" under the "MAX IN" mark.

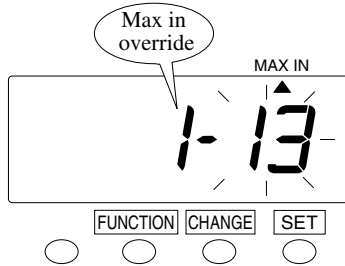

Set the "Max In Override".

	Order Option
1	No
2	Yes

- 3 In the case of the example, push the **CHANGE** button to set the left-side number at "1" and then push the **SET** button. At that moment, the flashing of the display will change to the right-side number.

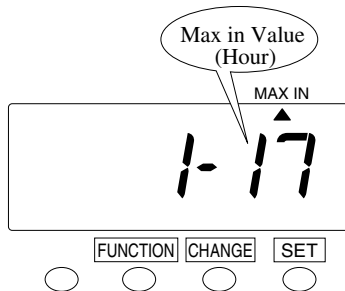

Set the "Max In Value".

- 4 In this case, push the **CHANGE** button to set at "17". And then push the **SET** button.

Range of value: 1 - 24 hours

- 5 Push the **SET** button once again.

Setting the Button Function

Refer to "Functions for the buttons" before setting.

Example
Select "Required" for the button.

	Order Option
1	Required
2	Optional
3	Disabled

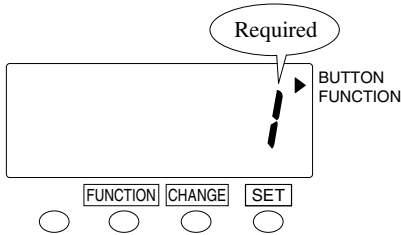
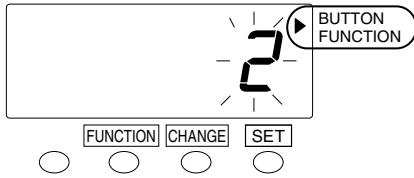

- 1 Push the **FUNCTION** button for 3 seconds.
- 2 Push the **FUNCTION** button and position the "▲" next to the "BUTTON FUNCTION" mark.
- 3 In the case of the example, push the **CHANGE** button to set at "1". And then push the **SET** button.
- 4 Push the **SET** button once again.

Setting the Daylight Saving Time

Daylight saving time function

1 D.S.T. execution time

At 2:00 a.m. on the first day of summer time, the clock automatically gains one hour to show 3:00 a.m. When 2:00 a.m. comes on the last day of the summer time period, it loses one hour and returns to 1:00 a.m.

2 Setting D.S.T.

Example:

Start date Sunday, March 30, 2003

End date Sunday, October 26, 2003

If set as the above, the unit remembers the start date as the last Sunday of March and the end date as the last Sunday of October. Once set, the unit automatically updates the settings every year thereafter. No further manual setting is necessary.

When there is a time change between the "IN" and "OUT" because of the "Daylight Savings" settings, an "S" will appear on the calculated result as a record mark.

In order to prevent miscalculations on the day you adjust the "Daylight Savings" time, punching "OUT" the next day is not desirable.

The "S" mark may not be printed properly when "Daylight Savings" turned on because of other changes in settings.

_____ The setting for daylight saving time will be _____
described using the following example.

Example

Today (present day)	Wednesday, January 29, 2003	
Starting date of daylight saving time	Sunday, March 30, 2003	The last Sunday of March
Ending date of daylight saving time	Sunday, October 26, 2003	The last Sunday of October



- 1 Push the **FUNCTION** button for 3 seconds.
- 2 Push the **FUNCTION** button and position the "▲" next to the "DAYLIGHT SAVINGS" mark.

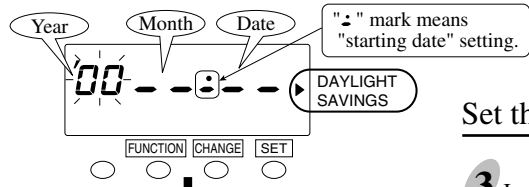

Set the "starting date".

- 3 In the case of the example, push the **CHANGE** button to set at "03" and push the **SET** button. At that moment, the flashing changes from "Year" to "Month".

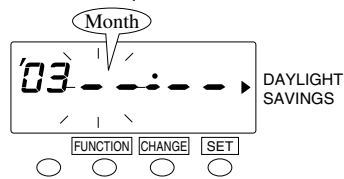

- 4 Push the **CHANGE** button to set at "3" and push the **SET** button. At that moment, the flashing changes from "Month" to "Date".

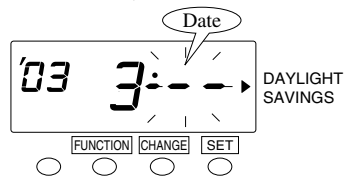
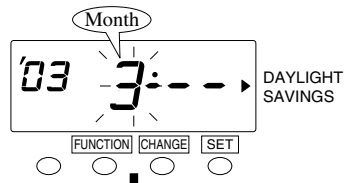

- 5 Push the **CHANGE** button to set at "30" and push the **SET** button. At that moment, "starting date" of the display changes from flashing to steady and the "▲" mark is displayed under "SU". Wait a few seconds, then start on Step 6.

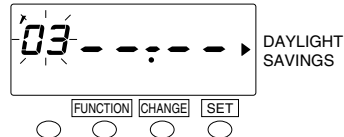
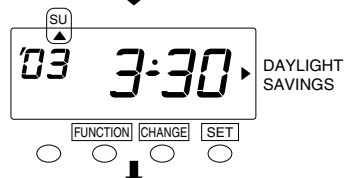
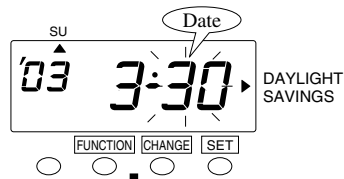

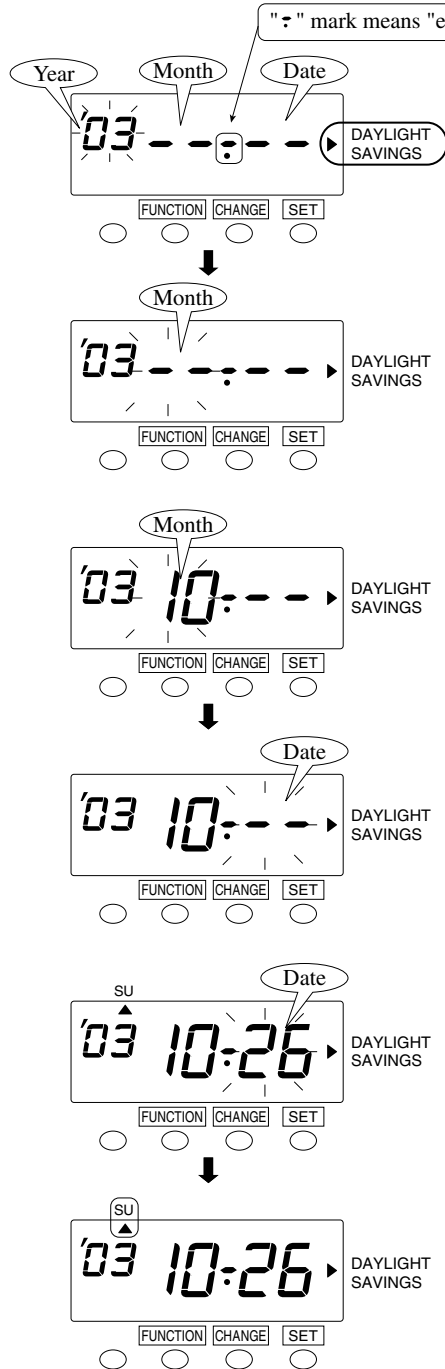

Set the "ending date".

6 Next, push the **SET** button. At that moment, the flashing changes "Year" to "Month".

7 Push the **CHANGE** button to set at "10" and push the **SET** button. At that moment, the flashing changes from "Month" to "Date".

8 Push the **CHANGE** button to set at "26" and push the **SET** button. At that moment, "ending date" of the display changes from flashing to steady and the "▲" mark is displayed under "SU".

9 Push the **SET** button once again.

Deleting the daylight saving time settings

To delete and cancel the daylight saving time settings, change the display of "Month" of the starting setting to "--".

Example

To change March 30, 2003 of "starting date" and delete daylight saving time settings.

- 1 Push the **FUNCTION** button for 3 seconds.
- 2 Push the **FUNCTION** button and position the "▲" next to the "DAYLIGHT SAVINGS" mark.

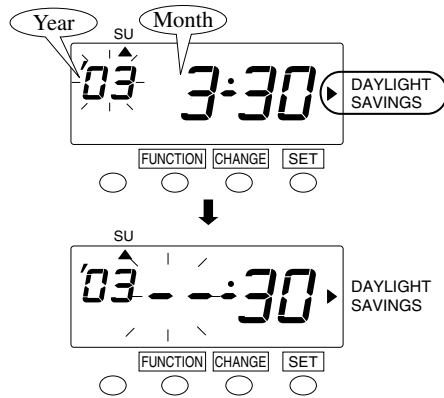

- 3 Push the **SET** button and the flashing changes from "Year" to "Month". Next, push the **CHANGE** button to set at "--".

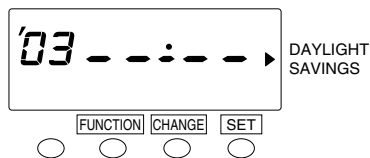

- 4 Push the **SET** button twice. This cancels the daylight saving time settings.
- 5 Push the **SET** button once again.

Setting the Print Language

The language English-Spanish-French can be selected to print "Month" and "the days of the week".

The print language can be selected from the following three types.

Order Options	Print Example: Thursday 3:30 p.m.
1. English	TH 3 : 30P
2. Spanish	JU 3 : 30P
3. French	JE 3 : 30P

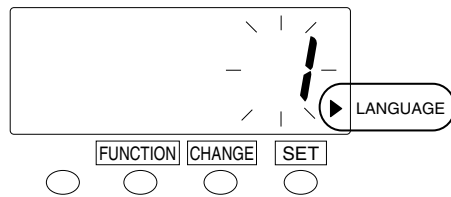

1 Push the **FUNCTION** button for 3 seconds.

2 Push the **FUNCTION** button to position the "▲" next to the "LANGUAGE" mark.

Push the **CHANGE** button to set the number at the desired print language. For example, set 3 if French is desired.

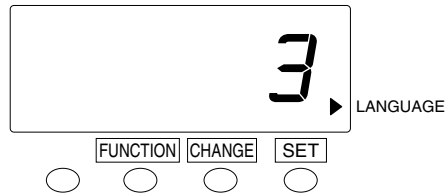

3 Push the **SET** button. At that moment, the display will change from flashing to steady.

4 Push the **SET** button once again.

Resetting

To return all settings to their factory defaults.

Please note that all settings will be deleted and will revert to the factory defaults when the reset switch is pushed. To make new settings, please refer to "6.SETTING".

If you want to reset all cards, refer to "All cards resetting" in "4.DAILY OPERATIONS".

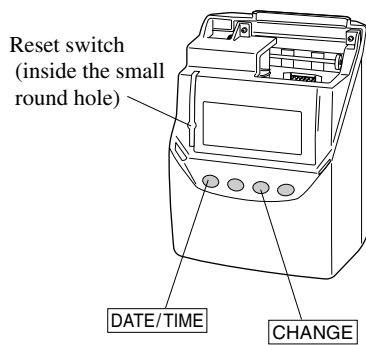

- 1 Push the reset switch with a pointed implement while pushing the **DATE/TIME** and **CHANGE** button.

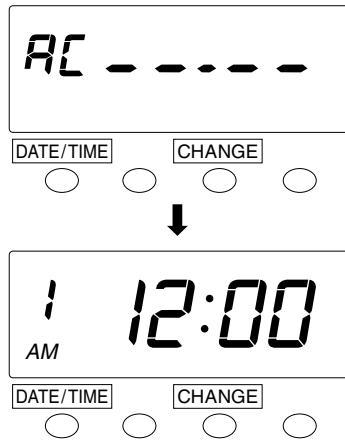

- 2 At that moment, the display will change to AC "-----". And after a few seconds, the display changes to date & time "1 12:00 a.m.".

7. PRINT EXAMPLE

No. 20 003
 Name SAM WHITE
 Period JULY 7
 Hours _____ Rate _____ Amount _____

IN	OUT	HOURS	ACCUMULATED TOTAL	TIME
902	1652	7:45	7:45	
901	1702	0:00	7:45	
901	1651	7:50	22:45	
900	1628	7:50	30:15	
901	1652	7:50	37:45	
905	1629	7:50	45:15	
900	1651	7:50	52:45	

Signature Sam White
 © 2002 Latham Time, Printed in the USA.

Annotations:
 - **Month**: Points to the '902' punch in the first row.
 - **Date**: Points to the '901' punch in the second row.
 - **Time**: Points to the '905' punch in the sixth row.
 - **Calculates time between punches**: Points to the '7:45' in the 'HOURS' column of the first row.
 - **Optional automatic break deduction from totals**: Points to the '0:00' in the 'HOURS' column of the second row.
 - **Accumulates total worked time**: Points to the '52:45' in the 'ACCUMULATED TOTAL' column of the last row.
 - **Verifies correct card number and side of card for printing**: Points to the '003' in the top right corner.

Note:

- "S" is to indicate totals across daylight savings adjustment.
- "*" is to indicate the following meanings.
 - (1) Rounded time result comes to 0:00
 - (2) Daylight savings adjustment was done in the period of calculation.
- "B" is to indicate accumulation result includes auto break deduction.

8. INSTALLING Ni-Cd BATTERY (Optional)

Follow the steps below to install a Ni-Cd battery (optional) in case of power failure.

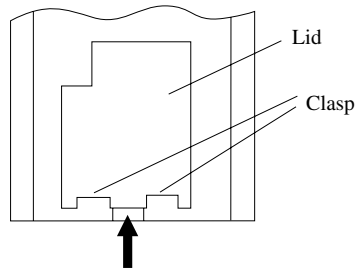

- 1** Remove the lid of the battery compartment on the back of the unit by pushing up the center of the lid, and then release it from the two clasps.

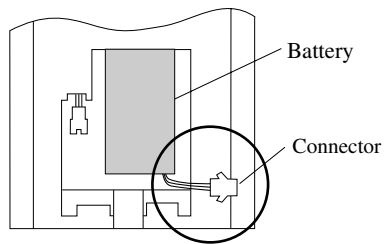

- 2** Position the battery as shown in the figure on the left.
* The connector cord should be on the right side, as shown in the figure.

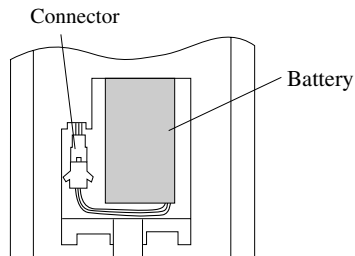

- 3** Connect the connector. Tuck away the connector cord into the open space in the compartment.

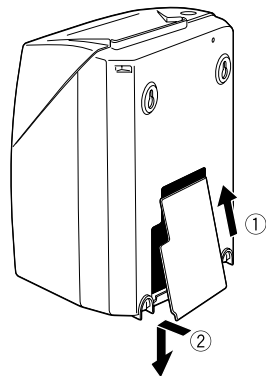

- 4** Insert the lid into the slot as shown on the left. Keep pressing it down until it hooks to the clasp.
* Make sure the cord is not caught when closing the lid.

9. TROUBLESHOOTING

Error No. appears

No.	Error contents	Action
E-00	CPU error	Contact the store from whom you bought the unit.
E-01	The remaining life of lithium battery for memory back-up is short.	
E-03	The front and back of the time card inserted is wrong.	Correctly insert the time card.
E-05	The card is not pulled in properly.	Make sure that another time card is not jamming in the time recorder. Try inserting the time card again.
E-15	Card sensor error	Make sure that another time card is not jamming in the time recorder and the ribbon cassette is correctly inserted in place.
E-30	The printer motor or the sensor is not normal.	After making sure of the above, close the cover.
E-37	The card forwarding motor or the sensor does not operate properly.	If the error number is still displayed, contact the store from whom you bought the unit.
E-38	The print head motor or the sensor for the printer head can not operate properly.	
E-41	The start date and the end date of the daylight saving time are the same date.	Correctly set the daylight saving time.
E-49	Input the wrong figures.	Check the setting contents and input the correct figures.
E-50	Can't use the time card.	Check the bar code area whether its smudged or damaged.
E-51	Punch error (Punch time error)	Check whether the time was turned back or not. Also check whether the card was inserted within 1 minute after the last punch.
E-52	Punch error (Punch logic error)	Check function for the buttons. Also check whether to reach the "Pay Period" day.
E-53	Over 50 time cards are used.	Check the number of the cards, which are used in current pay period and reset as needed.
END	When the card that you are using becomes full.	Use the "Card reassign" mode to transfer the card and have a new card take over for the old one.

MANUFACTURER'S WARRANTY

Limited One-Year Warranty

Lathem warrants the model 7000E hardware product against defects in material and workmanship for a period of one year from date of original purchase. The conditions of this warranty and the extent of the responsibility of Lathem Time Corporation ("Lathem") under this warranty are listed below.

1. This warranty will become void when service performed by anyone other than an approved Lathem warranty service dealer results in damage to the product.
2. This warranty does not apply to any product which has been subject to abuse, neglect, or accident, or which has had the serial number altered or removed, or which has been connected, installed, adjusted, or repaired other than in accordance with instructions furnished by Lathem.
3. This warranty does not cover dealer labor cost for removing and reinstalling the machine for repair, or any expendable parts that are readily replaced due to normal use.
4. The sole responsibility of Lathem under this warranty shall be limited to repair of this product, or replacement thereof, at the sole discretion of Lathem.
5. If it becomes necessary to send the product or any defective part to Lathem or any authorized service dealer, the product must be shipped in its original carton or equivalent, fully insured with shipping charges prepaid.
Lathem will not assume any responsibility for any loss or damage incurred in shipping.
6. **WARRANTY DISCLAIMER: Limitation of Liability.** Except in only the limited express warranty set forth above, there are no expressed or implied warranties of merchantability and fitness for a particular purpose. In no event will Lathem be liable for any direct, special, or consequential damages arising out of or in connection with the delivery, use or inability to use, or performance of this product.
7. Proof of date of purchase is required for warranty service on this product.
8. This Warranty grants specific legal rights. Additional legal rights, which may vary by locale, may also apply.
9. Should any difficulties arise with the performance of this product during warranty, or with any Lathem authorized service centers, contact Lathem Time at the address below.

Lathem Time Corporation

200 Selig Drive, SW, Atlanta, Georgia 30336

(800) 241-4990

(404) 691-1065

www.lathem.com

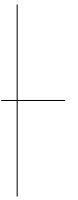
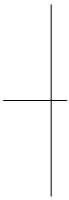
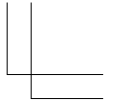
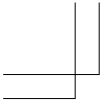

Form No. OM7E0209
Q0132-6120

